

Una Poulsen

Mandy on holiday

Avritssíður

Síðutølini í klombrum vísa til lesibókina.

Dagført 1. november 2006

Innihaldsyvirlit

Logbook

- Perma og frágreiðing
- My logbook 1 2

English words that I know

Island Travelling (s. 4)

- Spæl
- Frágreiðing um spælið
- Spurningar 1 2 3 4

Family Cards 1 2 3 4 (s. 8)

Travelling (s. 10, 88)

- Do you know the countries?

Colours (s. 12, 88)

- What is your favourite colour?
- Flags

Clothes (s.14, 86-87)

- Orðakort 1 2 3 4 5 6
- Myndir til spøl o.a.

Find the opposite word (s. 20-21)

- Opposite pairs 1 2 3 4 5 6
- Orð og týðningur

Animals and their young ones (s. 92-93)

- Memory 1 2

Zoo animals (s. 95)

- Memory 1 2 3 4
- Word cards, etc. 1 2 3 4 5
- Myndir til spæl o.a.

Numbers (s. 38-39, 101)

- Telephone numbers

The weather (s. 42-44, 90-91)

- Veðurkort / Ítriv 1 2 3
- Veðurkort – Memory 1 2
- What can you do? Memory 1 2 3 4
- What can you do? Domino 1 2
- Hobbies and sports 1 2 3 4 5

The clock (s. 49)

- Klokka við pinnum
- The clock – Word cards. 1 2 3 4 5

Peter and mandy go fishing (s. 52-54)

- Domino 1 2 3

Meals 1 2 3 4 (s. 57)

What do you wear? (s. 59, 86-87)

Helping on the farm (s. 60-62, 99)

- Domino 1 2 3
- Sheep words

Birthdays (s. 73-74, 101)

Christmas (s. 79-81)

- Memory 1 2 3
- Domino 1 2
- Put a tail on the donkey – spæl

Rammur til spøl

- 9 rammur
- 8 rammur
- 12 rammur
- Picture lottery
- Domino

Bingoplátur

- 4 puntar
- 9 puntar

Dømi um loggbók í byrjanarundirvísingini.
Næmingar læra at orða seg á enskum.

Avritssíða 1: Kopiera eitt eintak til permu.

Avritssíður 2 og 3: Kopiera tað tal av avritssíðum, sum tú ynskir.
Minst til at printa á báðum síðum.
Klipp eftir stiplaðu linjuni, falda og heft.

What I did at home:

Næmingarnir skriva stutt, hvat ið teir gjørdu heima.
Teir kunnu t.d. hava sæð ein enskan film
ella spælt eitt telduspæl við enskum teksti.

What I did at school:

Næmingarnir skriva stutt, hvat ið teir gjørdu í skúlanum.
Teir seta merki við eitt av SMILEY-andlitunum fyri at siga,
hvussu teimum dámdi.

Homework:

Næmingarnir skriva, hvat ið teir *fara at gera / skulu gera* heima.

My logbook

Name:

Date: _____

What I did at home:

What I did at school:   

Homework: 

Date: _____

What I did at home:

What I did at school:   

Homework: 

Date: _____

What I did at home:

What I did at school:   

Homework: 

Date: _____

What I did at home:

What I did at school:   

Homework: 

Date: _____

What I did at home:

What I did at school:   

Homework: 

Date: _____

What I did at home:

What I did at school:   

Homework: 

Date: _____

What I did at home:

What I did at school:   

Homework: 

Date: _____

What I did at home:

What I did at school:   

Homework: 

English words that I know

✓ Tick the words that you know (Set merki við tey orð, sum tú kennir)

Sports

badminton
bowling
basketball
crawl
hockey
jockey
knock-out
old boys
skateboard
surfing
rugby

Spare time & hobbies

babysitter
breakdance
bingo
camera
camping
jogging
party
quiz
swimming pool
weekend
western

Music & technology

cassette
computer
disc jockey
ghetto blaster
rock
TV
video
walkman

Food and drink

bacon
burger
cornflakes
hot dog
juice
milkshake
popcorn
sandwich
soft ice
toast

Clothes

boxer shorts
jeans
overalls
pyjamas
shorts
T-shirt

Other words

baby
carport
container
cowboy
gangster
handicap
interview
punk
shampoo
tape

Island Travelling • Frágreiðing um spælið

Island Travelling kann takast av netinum í passandi stødd og laminerast.
Spælið er ætlað at læra næmingarnar oyggjarnar, samstundis sum teir læra nýggj ensk orð. (www.fsg.fo – Mandy on holiday)

Tal av spælarum: tveir ella fleiri

Tú skalt nýta:

- ein terning
- brikkar í ymsum litum, ein brikk til hvønn spælara
- myndakort

48 myndakort við svarlista eru til spælið. Tey kunnu takast av netinum og laminerast.

Næmingarnir kunnu móguliga lita kortini.

Nýggj kort kunnu gerast til spælið, tá ið ein tíð er fráliðin.

Spælararnir skiftast at ringla og flyta sínar brikkar eftir tølunum.

Tað ræður um at verða fyrstur aftur á START.

Kemur ein spælari á reyðan ring, skal hann fyrri at kunna flyta siga, hvat stað á kortinum talið sipar til.

Hann skal síðani taka eitt myndakort og á enskum siga,

hvat myndin á kortinum vísir. Dugir hann tað, kann hann flyta brikkin eitt fram.

Gev gætur!

Í fyrstani kann næmingurin móguliga sleppa at flyta á reyðan ring, sjálvst um hann ikki veit navnið á staðnum.

Spælararnir kunnu so í felag finna út av navninum.

-
- brikkur: *counter / piece / man*
 - terningur: *dice*
 - terningabikar: *dicebox / dice cup / shaker*
 - at ringla: *to throw the dice / to rattle (the dice)*
 - at fáa ein seksara: *to throw a six (on the dice)*

Island Travelling • Svarlisti til kort

1. school bag (*skúlataska*)
2. pencil case (*penalarhús*)
3. books (*bøkur*)
4. pencil (*blyántur*)
5. pen (*pennur*)
6. eraser (*viskileður*)
7. crayon (*litblyántur*)
8. ruler (*lineal*)
9. car (*bilur*)
10. bus (*bussur*)
11. aeroplane (*flogfar*)
12. helicopter (*tyrla*)
13. train (*tok*)
14. sheep (*seyður*)
15. rat (*rotta*)
16. pig (*grísur*)
17. starling (*stari*)
18. sparrow (*spurvur*)
19. crow (*kráka*)
20. pigeon (*dúgva*)
21. hare (*hara*)
22. marsh marigold (*mýrisólja*)
23. daisy (*summardái*)
24. daffodil (*páskalilja*)
25. cat (*ketta*)
26. goose (*gás*)
27. duck (*dunna*)
28. dog (*hundur*)
29. pilot whale (*grindahvalur*)
30. shark (*hávvur*)
31. monkey (*apa*)
32. kangaroo (*kenguru*)
33. giraffe (*giraffur*)
34. horse (*ross*)
35. crocodile (*krokodilla*)
36. elephant (*filur*)
37. bear (*bjørn*)
38. lion (*leyva*)
39. tiger (*tikari*)
40. panda (*panda*)
41. camel (*kamelur*)
42. seal (*kópur*)
43. snake (*slanga*)
44. zebra (*sebra*)
45. rhino (*nashyrningur*)
46. polar bear (*hvítabjørn*)
47. hippo (*áarross*)
48. penguin (*pingvin*)

Nøvn á kortinum

3. the Faroe Islands
7. the Shetland Islands
10. the Orkney Islands
12. Scotland
15. England
18. the Isle of Wight
21. the Channel Islands
25. the Isles of Scilly
28. Wales
31. the Isle of Man
34. Ireland
37. Northern Ireland
40. the Hebrides
[ˈhebridiːz]

Island Travelling • Spurningar (1) 2 3 4

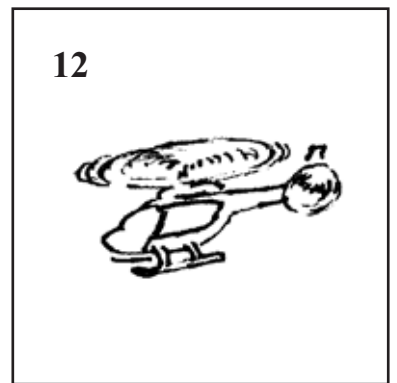
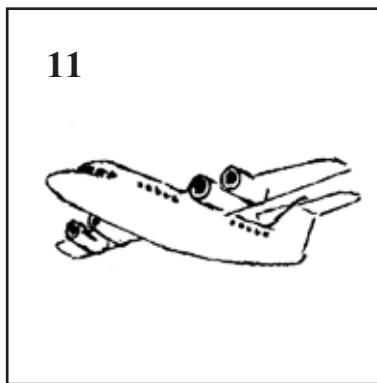
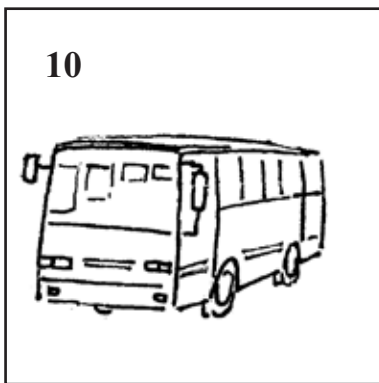
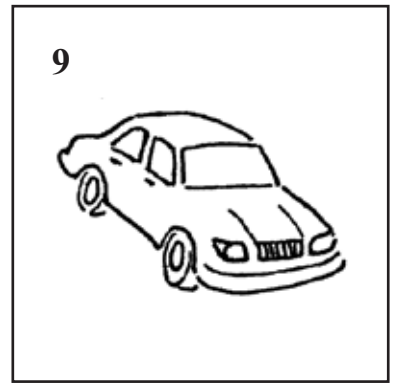
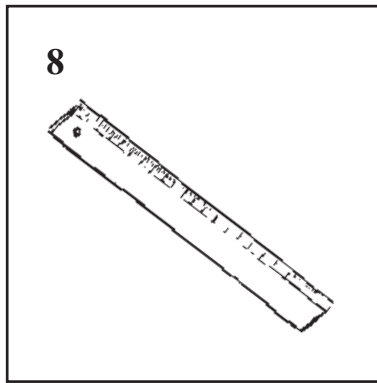
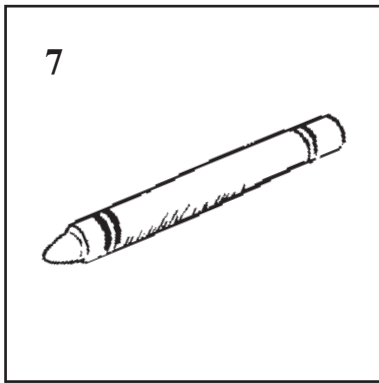
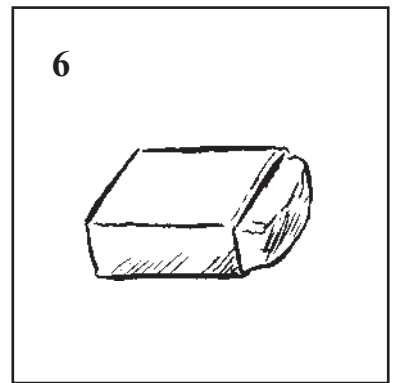
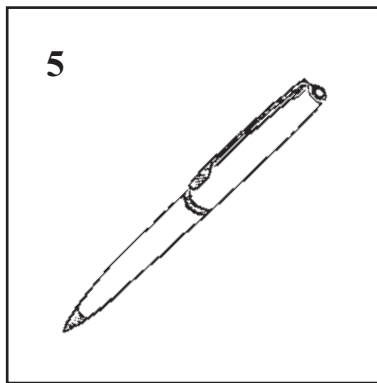
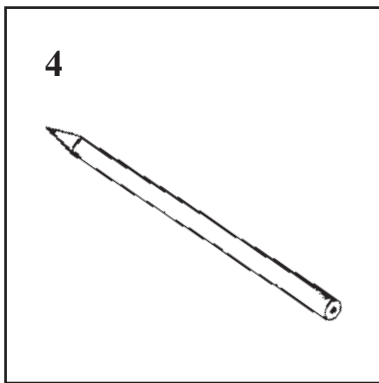
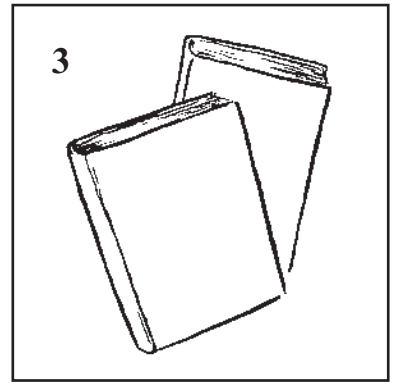
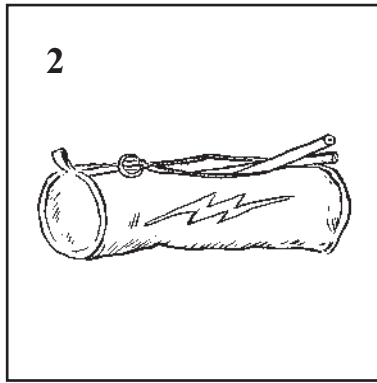
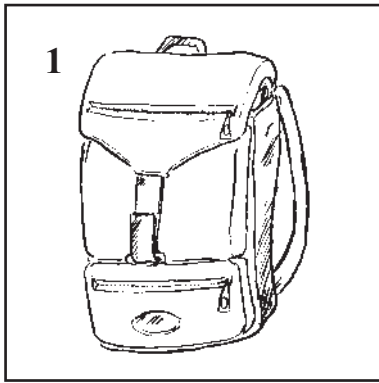

Island Travelling • Spurningar 1 (2) 3 4

13

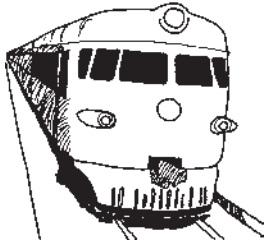

14



15



16

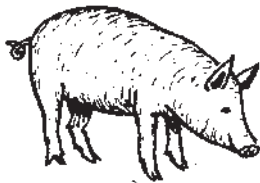

17



18



19



20



21



22



23



24



Island Travelling • Spurningar 1 2 (3) 4

25



26

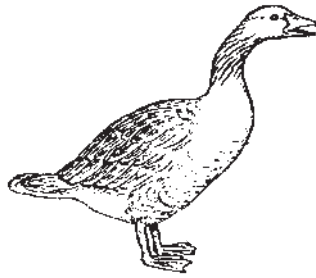

27



28



29



30



31



32



33



34

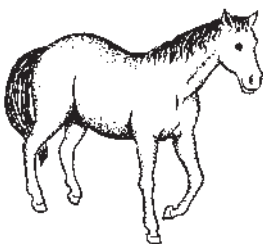

35

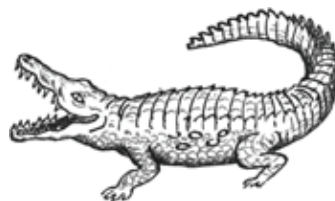

36

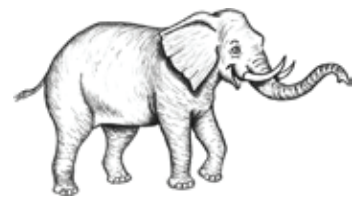

37



38



39



40



41



42



43



44



45

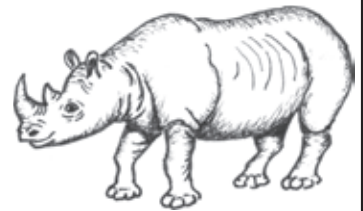

46



47



48



Family cards

1

2

3

4



Maria



John



Martin



Katrina



George



Tim



Peter

Mandy



Susan



Family cards 1 (2) 3 4

**Peter's
mother**

**Peter's
father**

**Peter's
brother**

**Mandy's
mother**

**Mandy's
father**

**Mandy's
brother**

Peter

Mandy

**Mandy's
sister**

Family cards 1 2 (3) 4



Súsanna



Pætur



Edmund



Anna



Minnie



Fluffy



Family cards 1 2 3 ④

**Peter and
Mandy's
grandmother**

**Peter and
Mandy's
grandfather**

**grandfather's
dogs**

**Uncle
Edmund**

Aunt Anna

**Peter's
house**

**Peter's
mouse**

**Mandy's
cat**

**Mandy's
house**

Do you know the countries

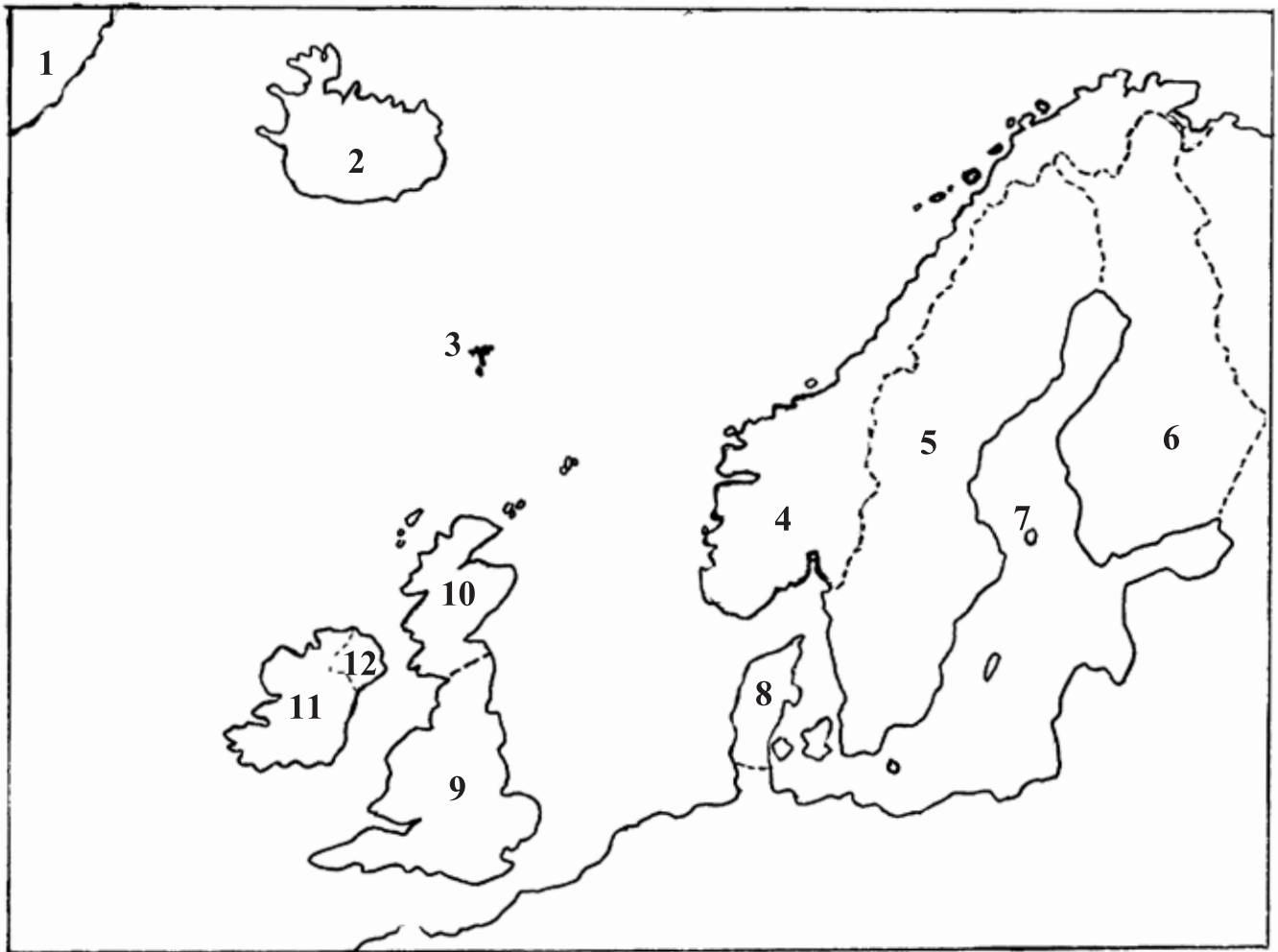

Write the names of the countries and colour the map.

- | | |
|----------|-----------|
| 1. _____ | 7. _____ |
| 2. _____ | 8. _____ |
| 3. _____ | 9. _____ |
| 4. _____ | 10. _____ |
| 5. _____ | 11. _____ |
| 6. _____ | 12. _____ |

In which countries have you been?

Colours • What is your favourite colour?

Ask some of your classmates about colours.

Give points

- Favourite colour: **three** points
- Other colours: **one** points

What is your favourite colour?
Name two other colours that you like.



Name of pupil	red	blue	green	yellow	purple	pink	orange	grey	white	black	brown
Points:											

The most popular colour: _____

Other well liked colours: _____ and _____

Do boys and girls like the same colours? Yes: No:

Colour the flags.

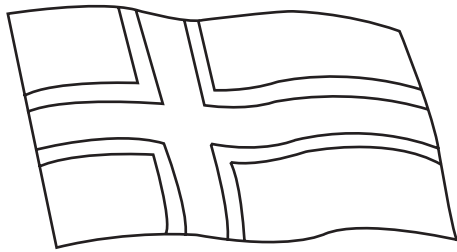

the Faroe Island

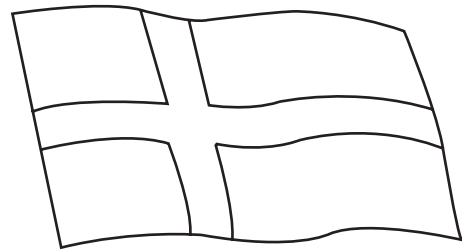

Denmark

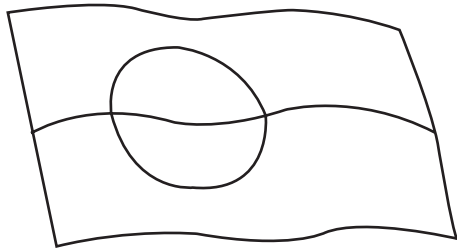

Greenland

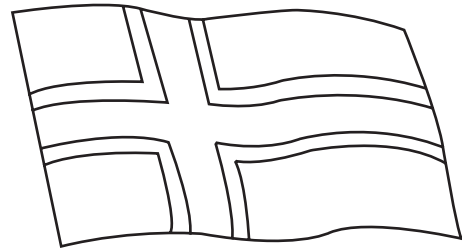

Iceland

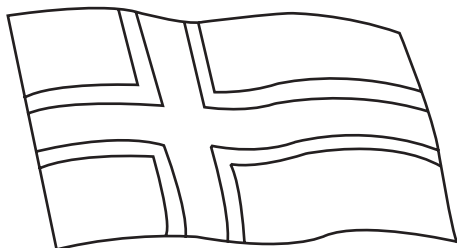

Norway

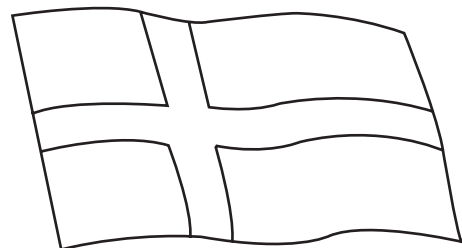

Sweden

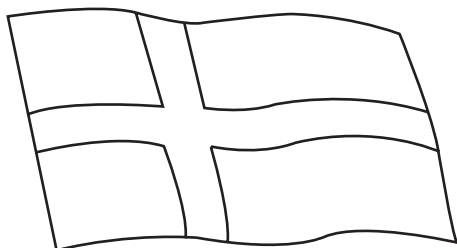

Finland

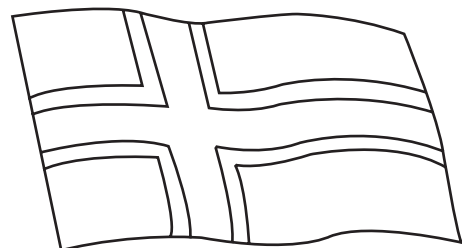

the Aland Islands

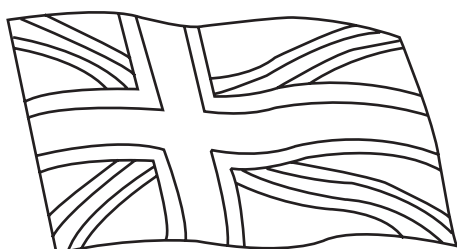

the United Kingdom

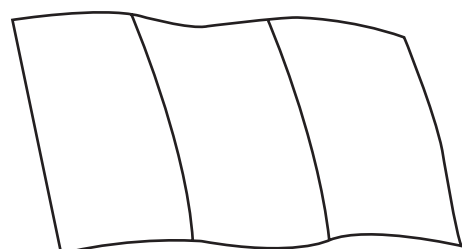

Ireland

Clothes • Orðakort (1) 2 3 4 5 6

T-shirt

sweater

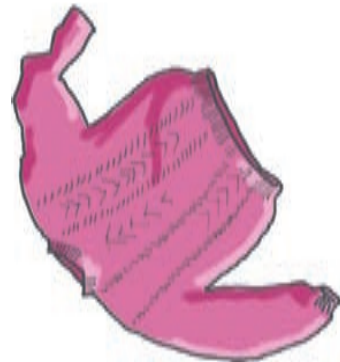

sweatshirt

trousers



nighdress

blouse



jacket

skirt



swimsuit

underwear



scarf

wellingtons



Clothes • Orðakort 1 2 3 4 5 6

sandals

shoes



jeans

raincoat



Clothes • Orðakort 1 2 3 4 5 6

trainers

socks



dress

cardigan

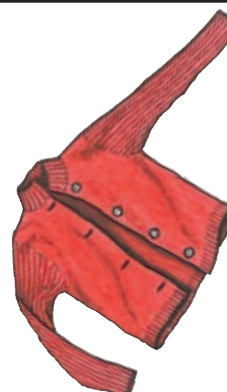
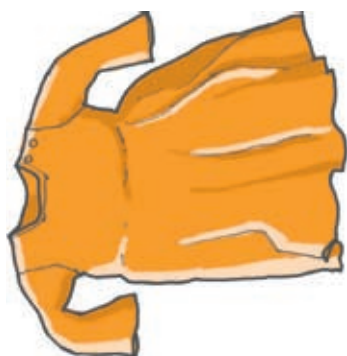

Clothes • Orðakort 1 2 3 4 5 6

pyjamas

ski suit

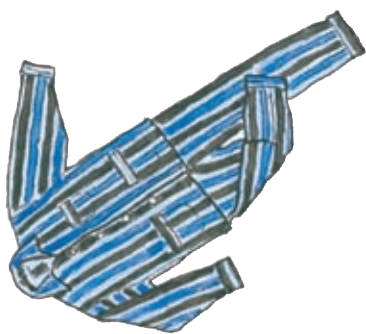

track suit

trunks



Clothes • Myndir til spøl o.a.

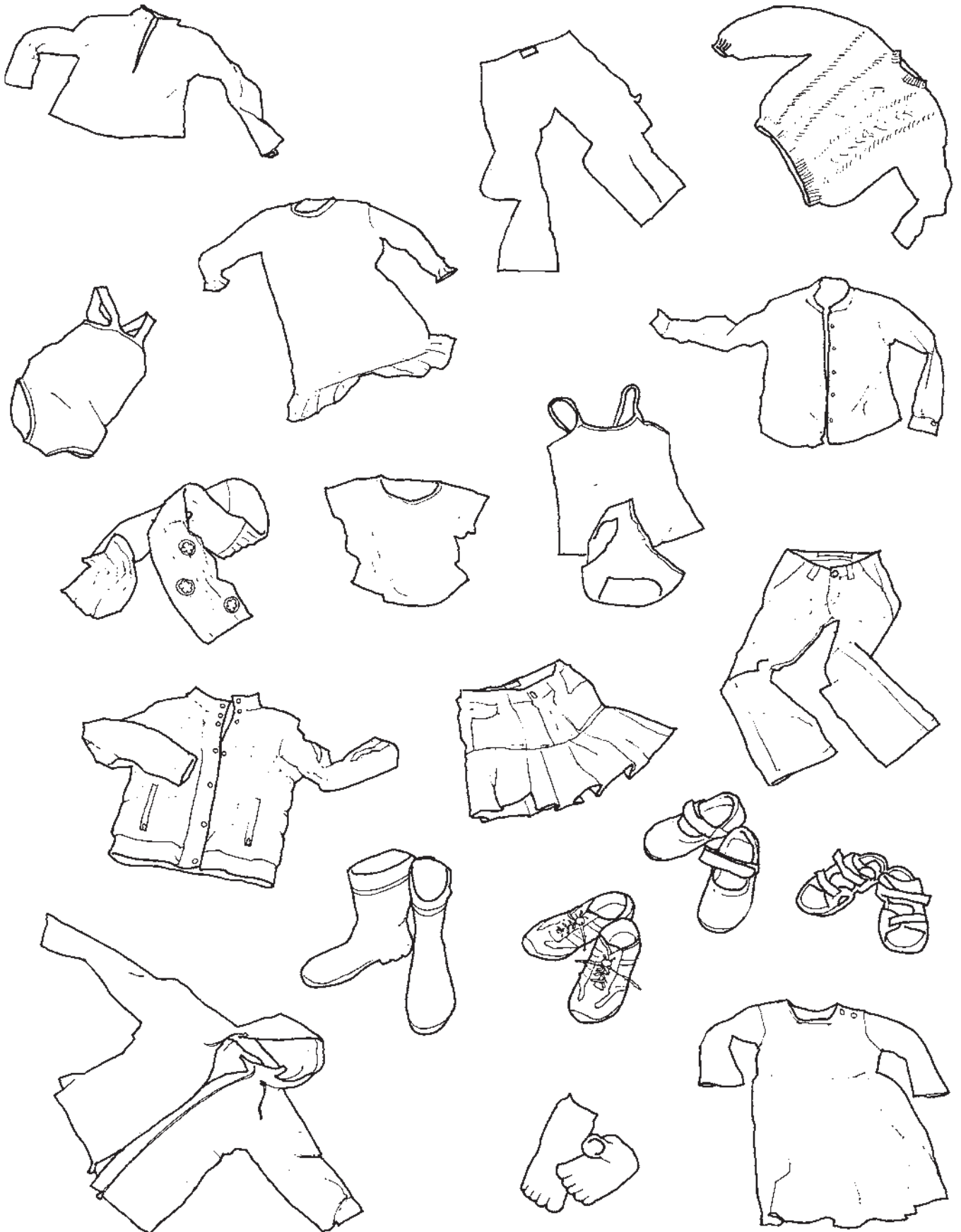

Opposite pairs

1

2

3

4

5

6

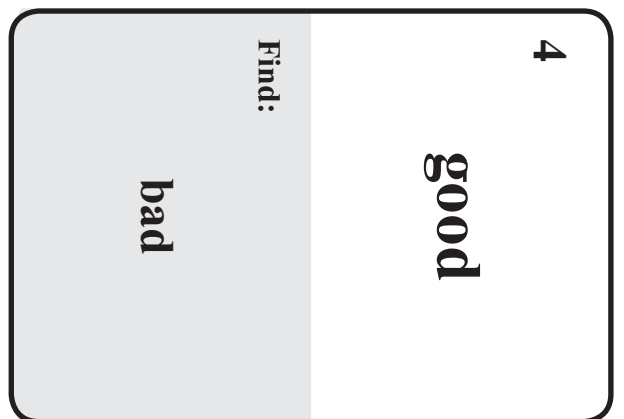
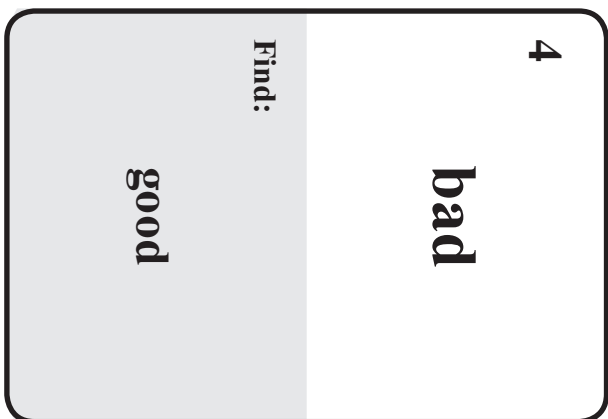
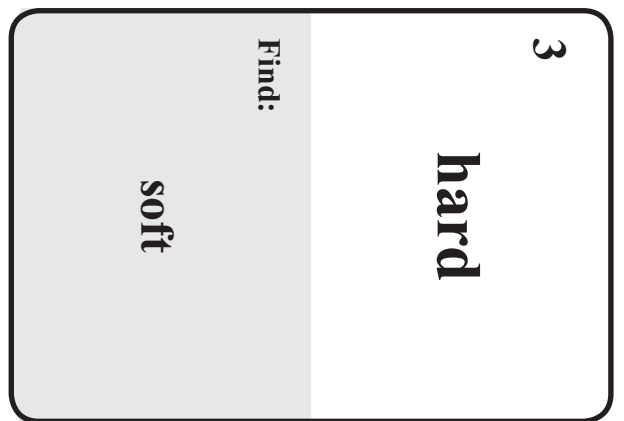
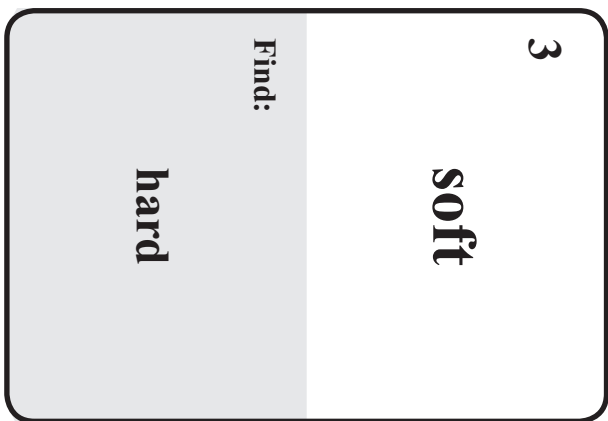
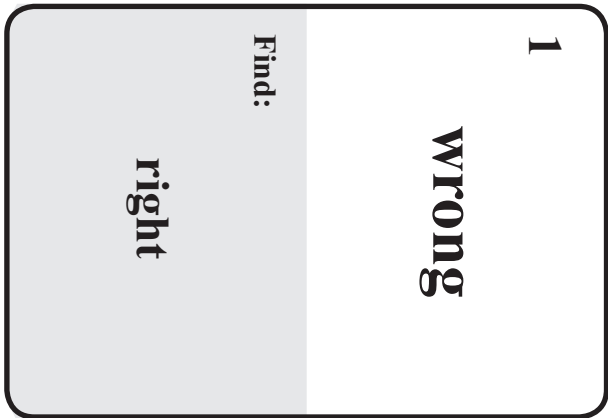

Opposite pairs 1 (2) 3 4 5 6

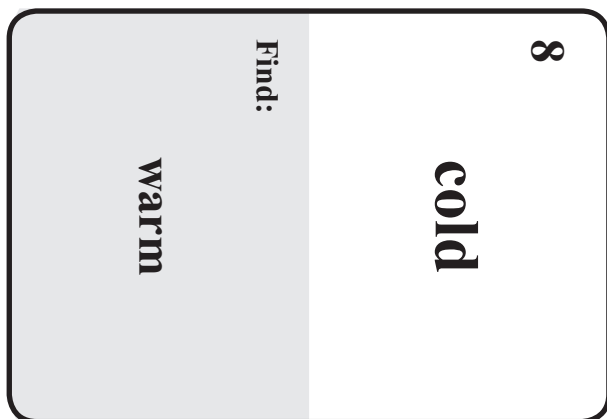
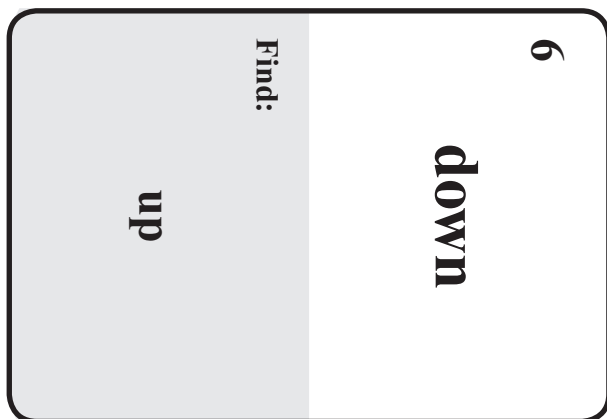
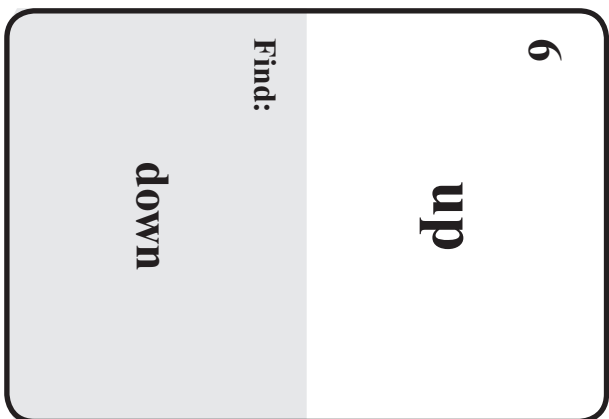
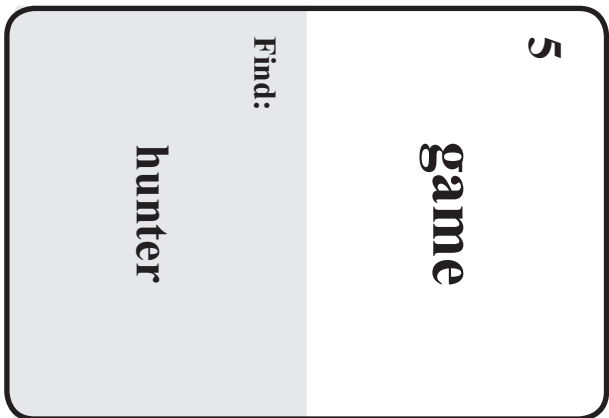

Opposite pairs

1

2

3

4

5

6

9

low

Find:

high

9

high

Find:

low

10

closed

Find:

open

10

open

Find:

closed

11

left

Find:

right

11

right

Find:

left

12

tame

Find:

wild

12

wild

Find:

tame

Opposite pairs 1 2 3 4 5 6

13

slow

Find:

fast

13

fast

Find:

slow

14

old

Find:

young

14

young

Find:

old

15

dry

Find:

wet

15

wet

Find:

dry

16

thin

Find:

fat

16

fat

Find:

thin

Opposite pairs 1 2 3 4 5 6

17
light
Find:
heavy

17
heavy
Find:
light

18
ugly
Find:
beautiful

18
beautiful
Find:
ugly

19
girl
Find:
boy

19
boy
Find:
girl

20
woman
Find:
man

20
man
Find:
woman

Opposite pairs 1 2 3 4 5 6

21
quiet
Find:
noisy

21
noisy
Find:
quiet

22
top
Find:
bottom

22
bottom
Find:
top

23
short
Find:
tall

23
tall
Find:
short

24
small
Find:
big

24
big
Find:
small

Opposite word • Orð og týdningur

1. right / wrong *rætt / skeivt*
2. empty / full *tómt / fult*
3. hard / soft *hart / bleytt*
4. good / bad *gott / ringt*
5. hunter / game *veiðimaður / fongur*
6. down / up *niður / upp*
7. white / black *hvítt / svart*
8. cold / warm *kalt / heitt*
9. high / low *høgt / lágt*
10. open / closed *opið / aftur*
11. right / left *høgrri / vinstri*
12. wild / tame *vilt / tamt*
13. fast / slow *skjótt / seint*
14. young / old *ungt / gamalt*
15. wet / dry *vátt / turt*
16. fat / thin *feitt / klænt*
17. heavy / light *tungt / lætt*
18. beautiful / ugly *vakurt / ljótt*
19. boy / girl *drongur / genta*
20. man / woman *kona / maður*
21. noisy / quiet *larmut / stilt*
22. bottom / top *botnur / toppur*
23. tall / short *høgt / stutt*
24. big / small *stórt / lítið*

Animals and their young ones • Memory (1) 2



duck



cat

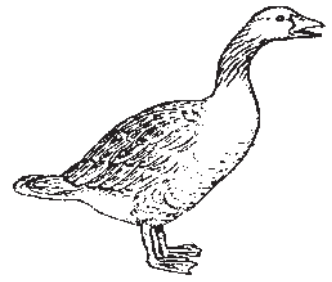

goose



duckling



kitten

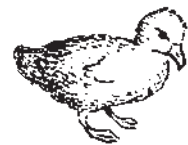

gosling

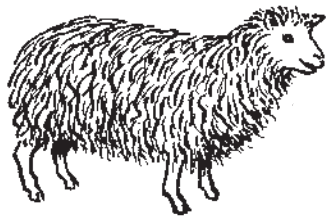

sheep



hen

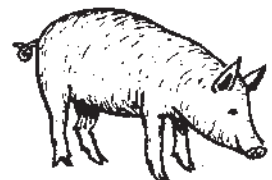

pig



lamb

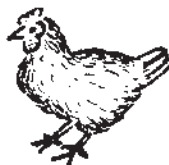

chicken



piglet

Animals and their young ones • Memory 1 (2)

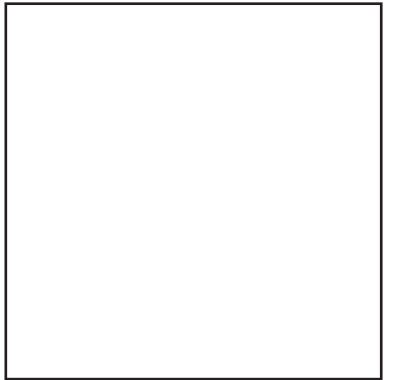
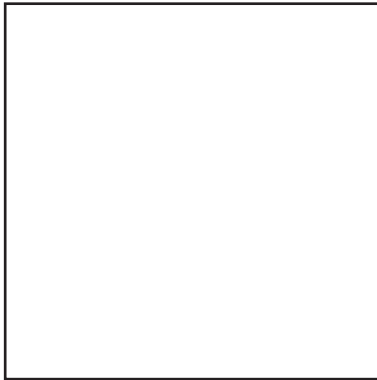
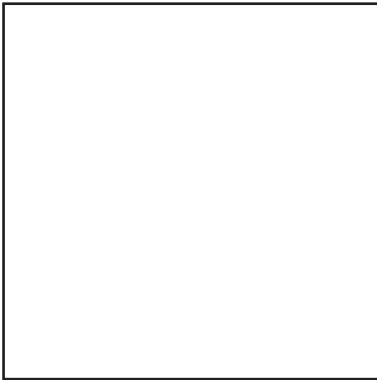
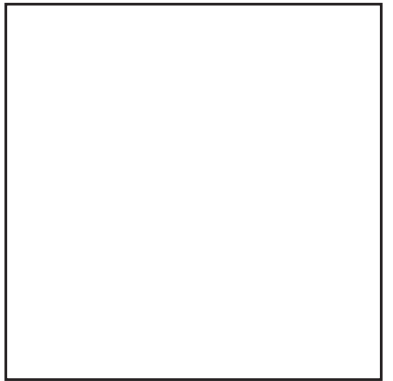
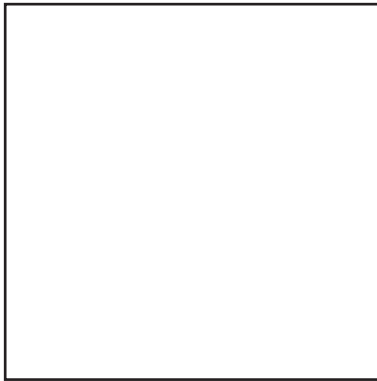
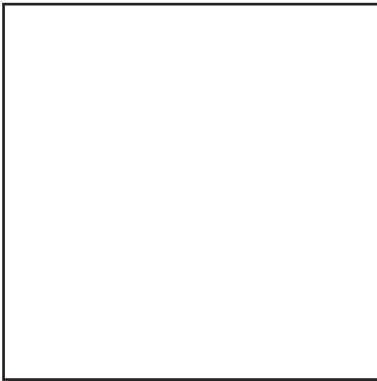
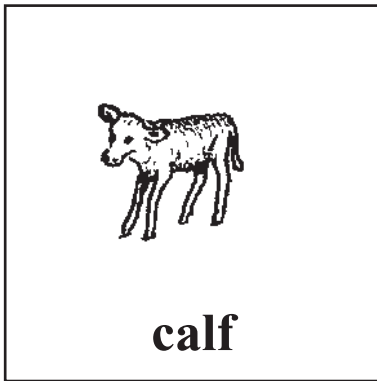
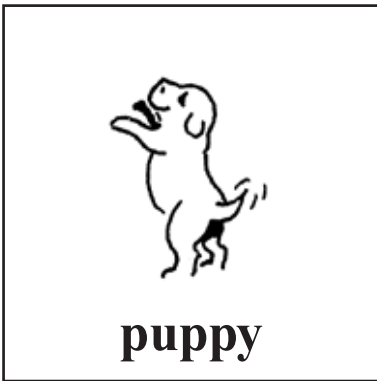
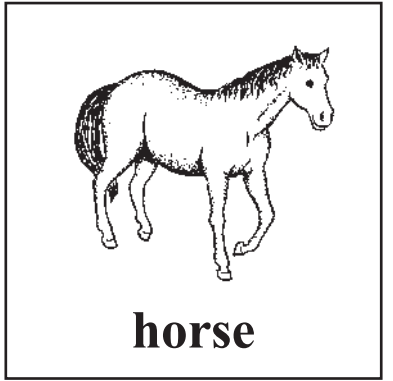
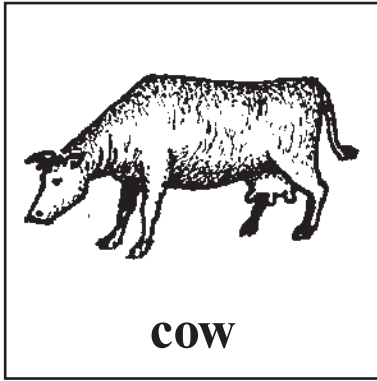
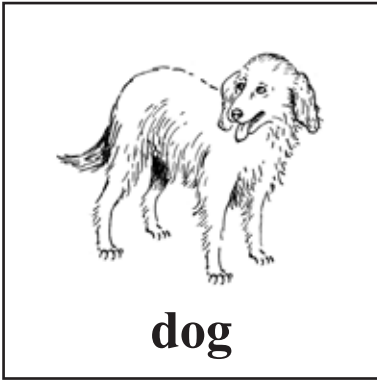

Zoo animals • Memory (1) 2 3 4

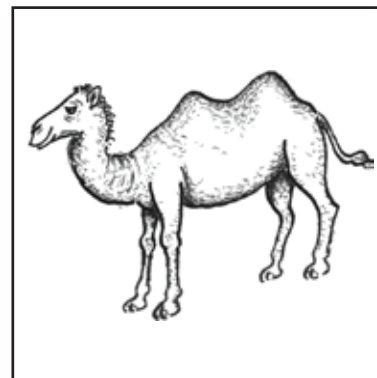
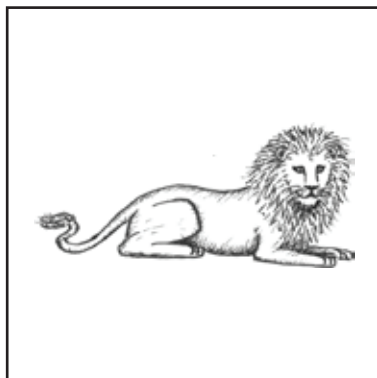
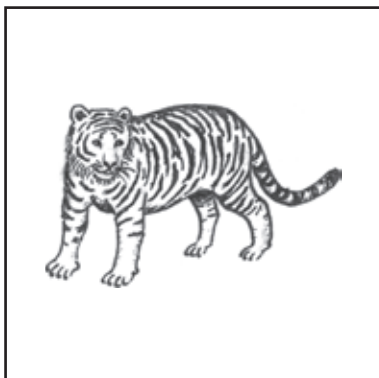
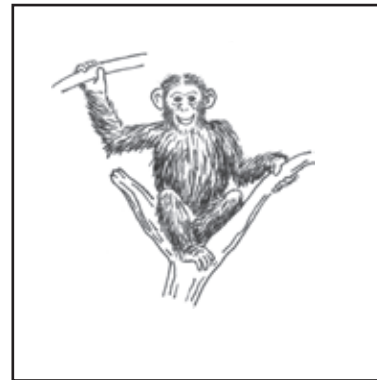
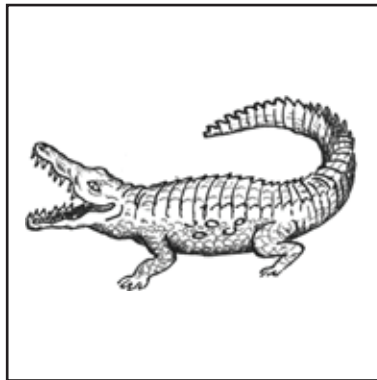
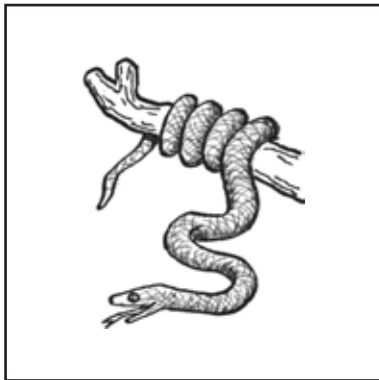

snake

crocodile

monkey

tiger

lion

camel

Zoo animals • Memory 1 (2) 3 4

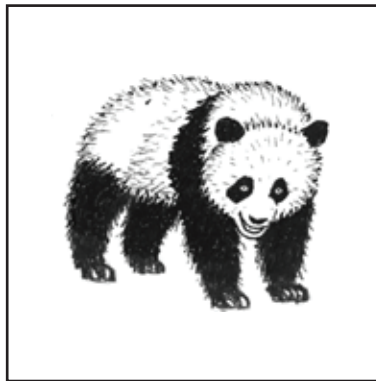
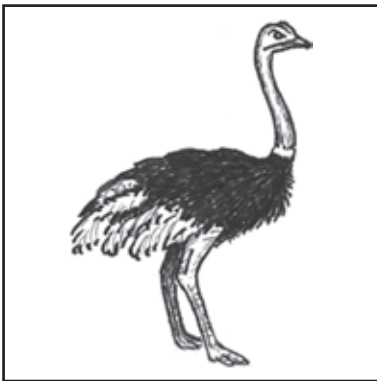
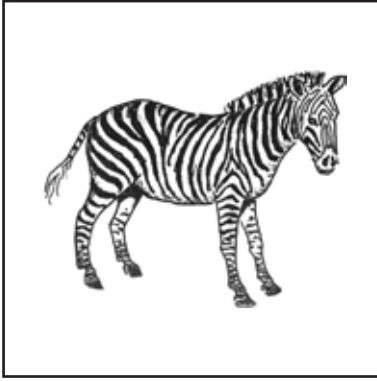

zebra

wolf

polar bear

ostrich

panda

brown bear

Zoo animals • Memory 1 2 (3) 4

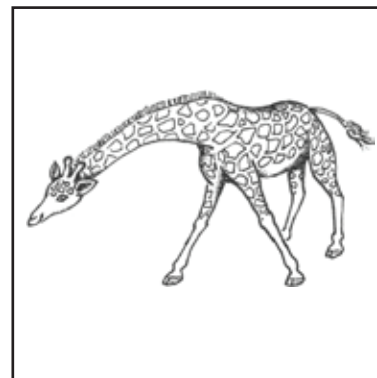
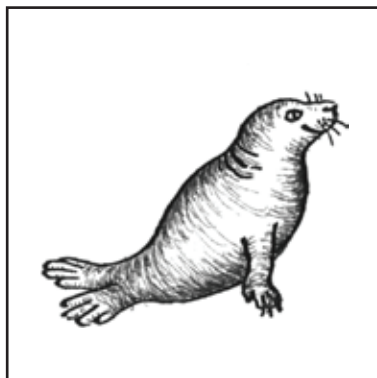
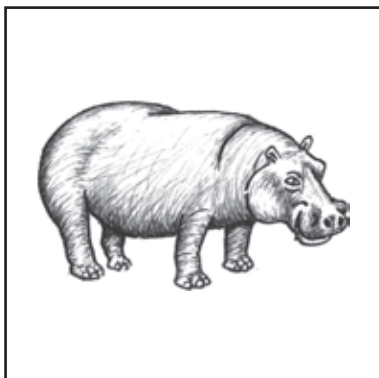
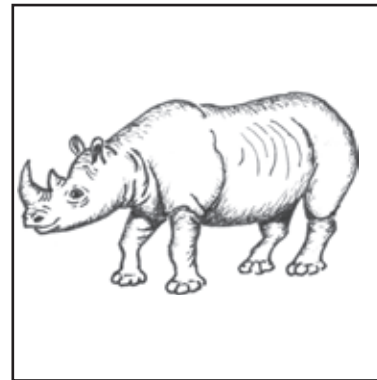
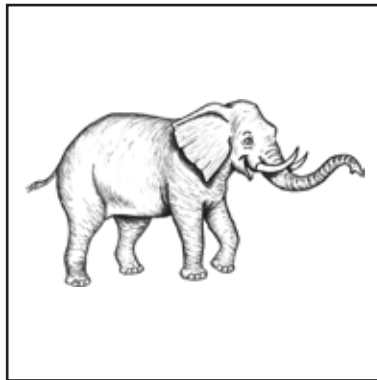
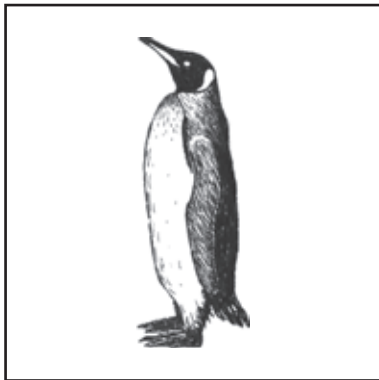

penguin

elephant

rhino

hippo

seal

giraffe

Zoo animals • Memory 1 2 3 4

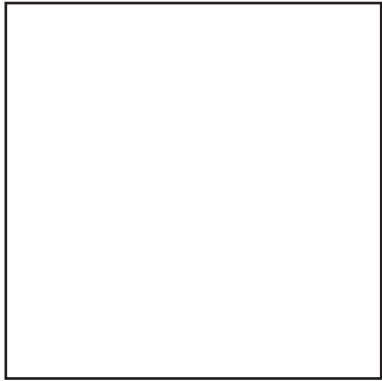

flamingo

kangaroo

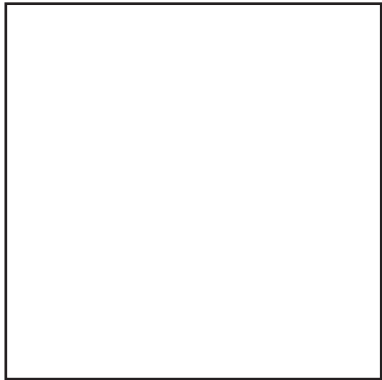
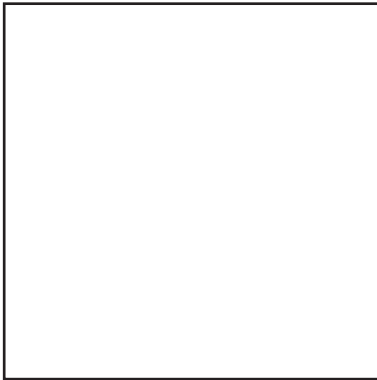
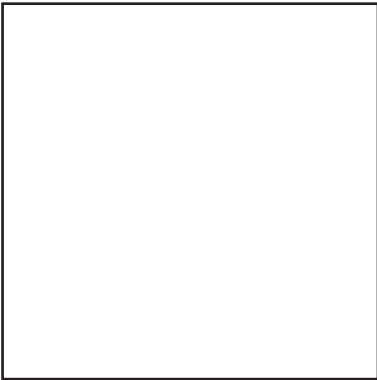
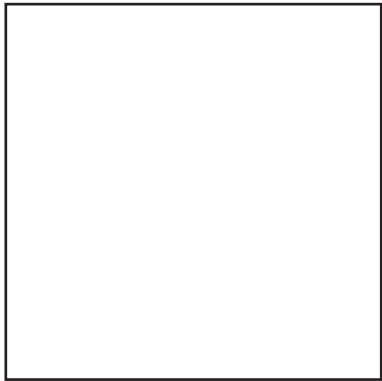
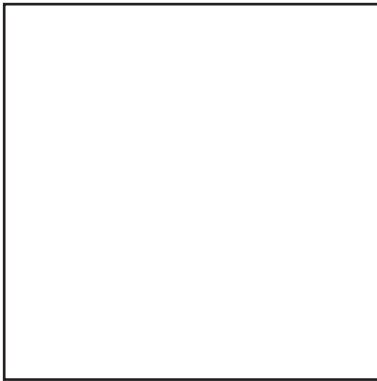
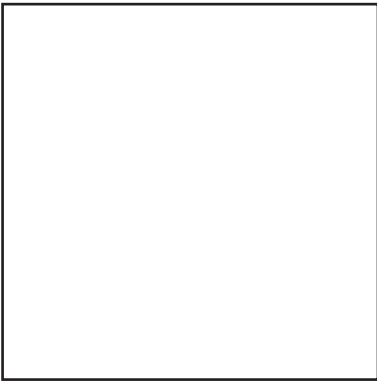
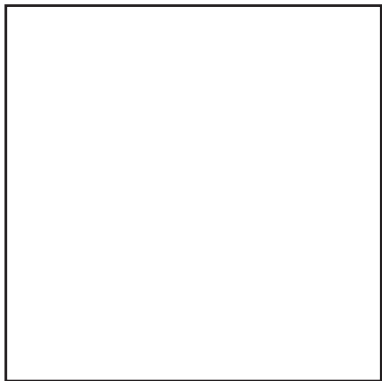

Zoo animals • Word cards, ect. ① 2 3 4 5

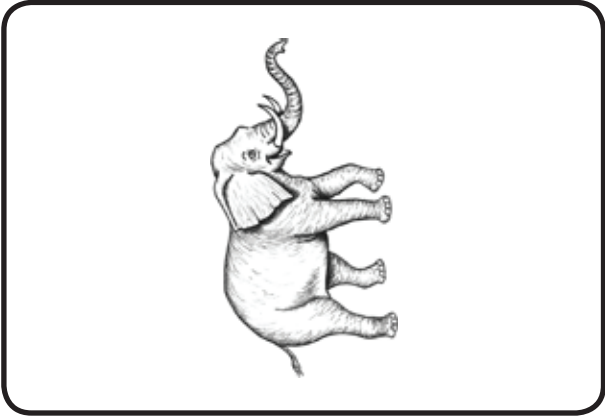

elephant



monkey



brown bear



polar bear

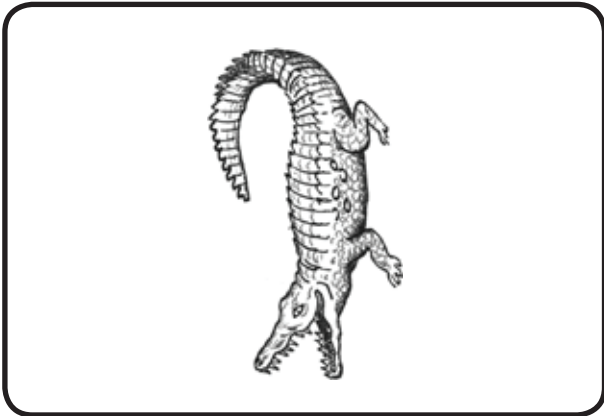

crocodile

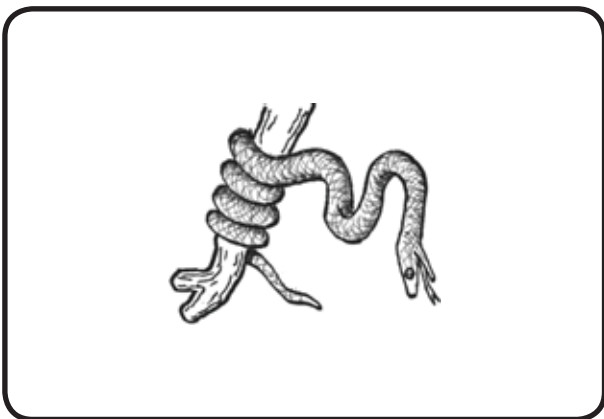

snake



ostrich

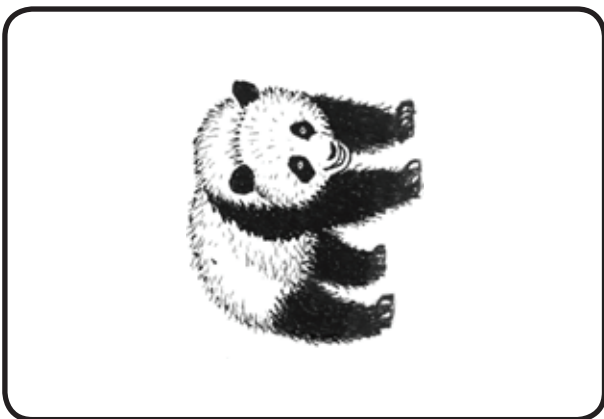

panda

Zoo animals • Word cards, ect. 1 2 (3) 4 5

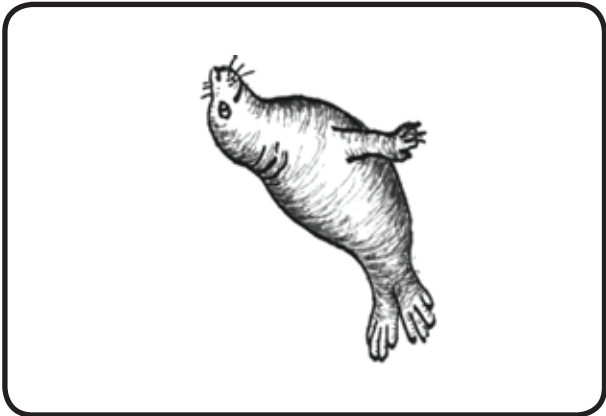

seal



lion



tiger



zebra

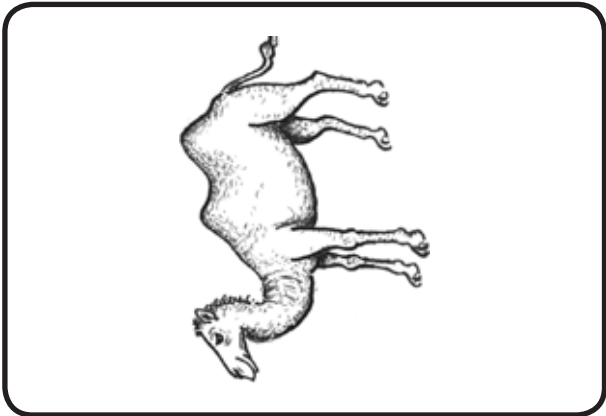

camel

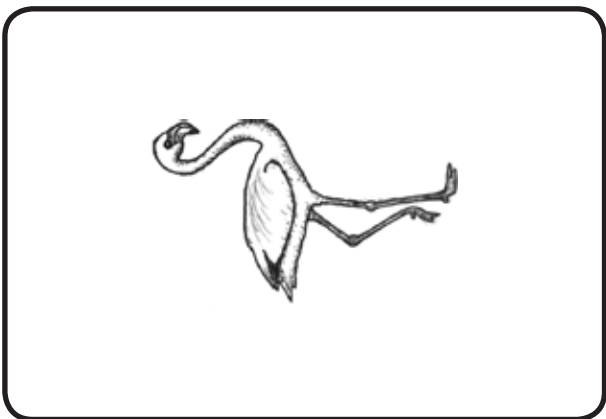

flamingo

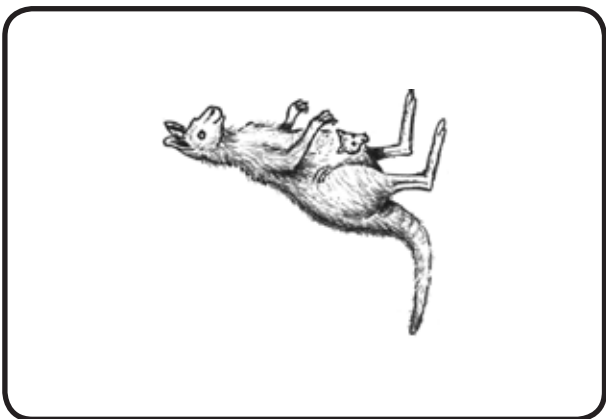

kangaroo



giraffe

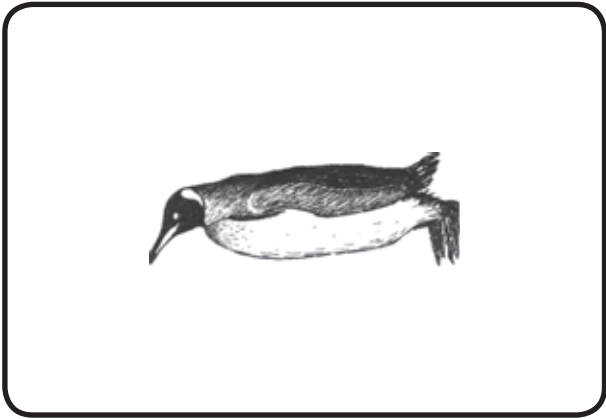

penguin

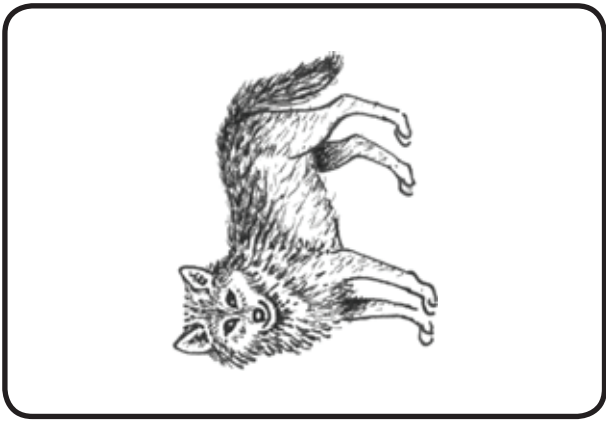

wolf



rhino

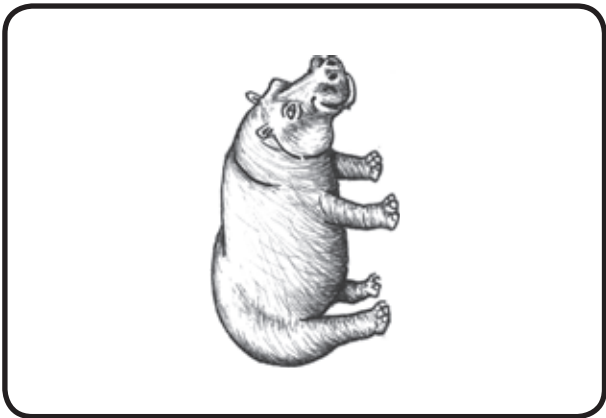

hippo

Zoo animals • Myndir til spøl o.a.

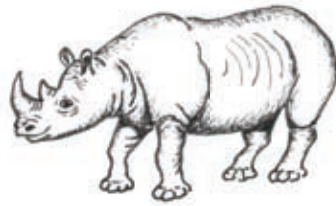
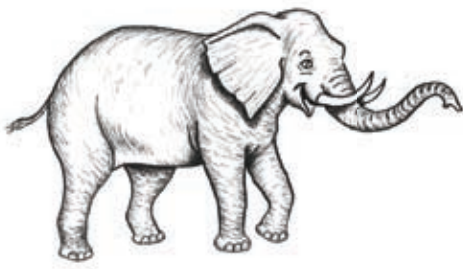

The weather • Veðurkort / Ítriv ① 2 3



It's foggy



It's foggy



It's foggy



It's windy



It's windy



It's windy



It's cold



It's cold



It's cold



It's freezing



It's freezing



It's freezing



It's warm



It's warm



It's warm



It's snowing



It's snowing



It's snowing

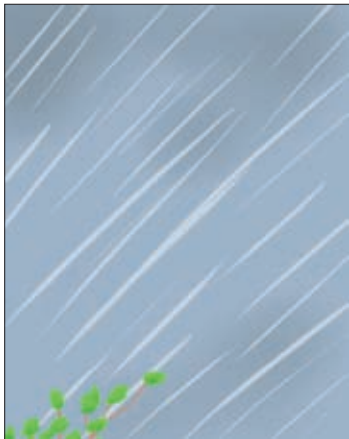

It's raining

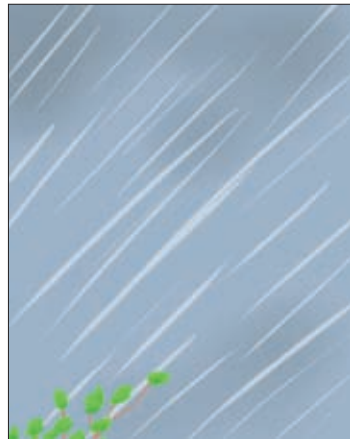

It's raining

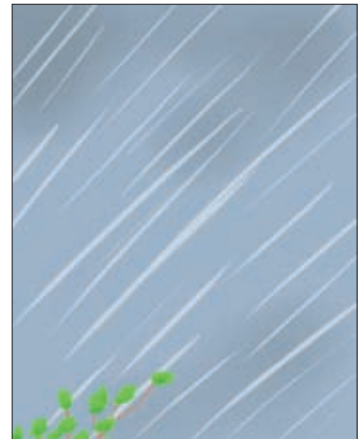

It's raining



It's hot



It's hot



It's hot



It's sunny

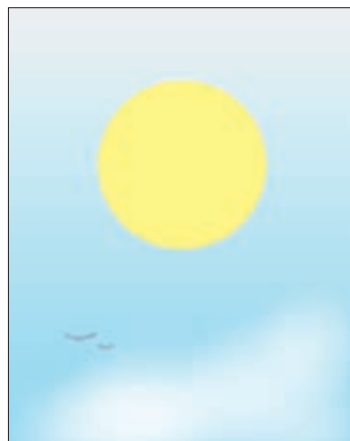

It's sunny



It's sunny

Veðurkort • Memory, ect. (1) 2

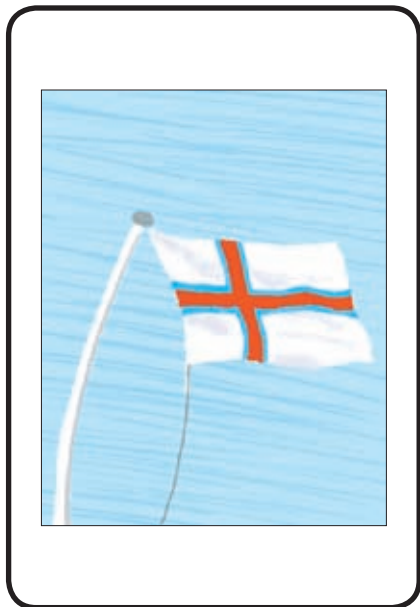
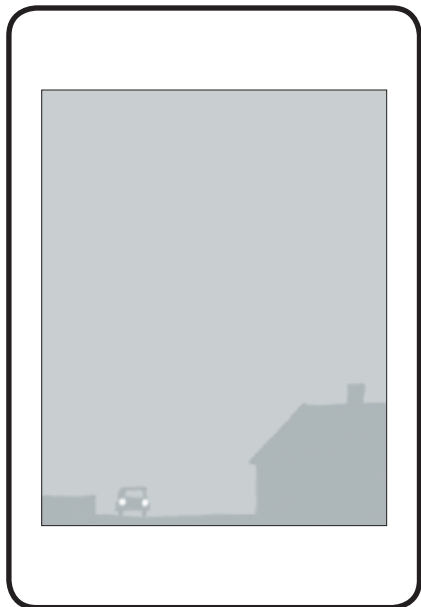
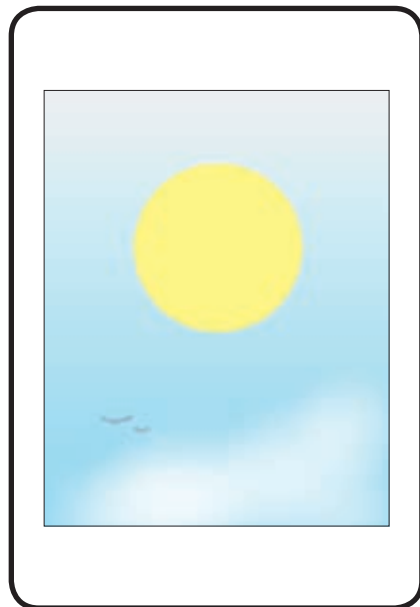
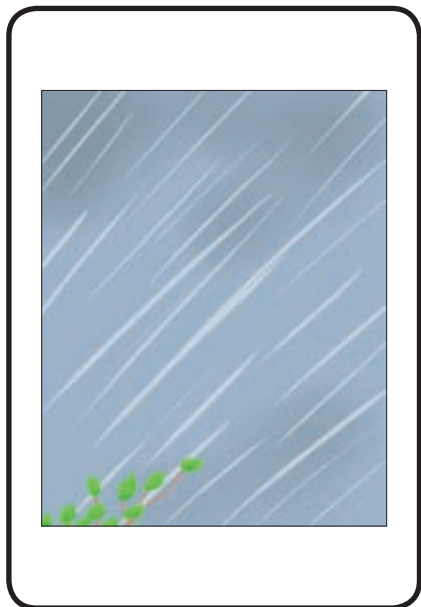

**It's
raining**

**It's
hot**

**It's
sunny**

**It's
foggy**

**It's
windy**

**It's
cold**

**It's
freezing**

**It's
warm**

**It's
snowing**

What can you do • Memory, ect. (1) 2 3 4

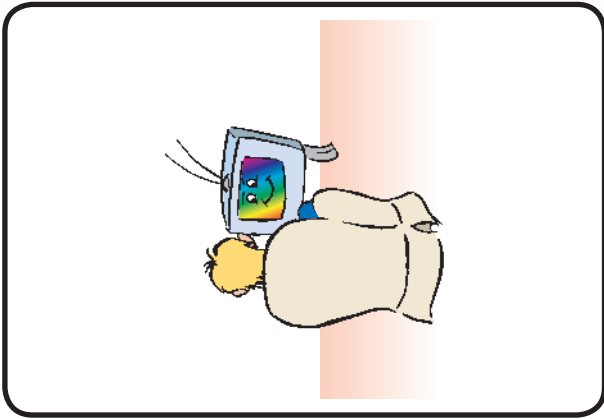

**watching
television**

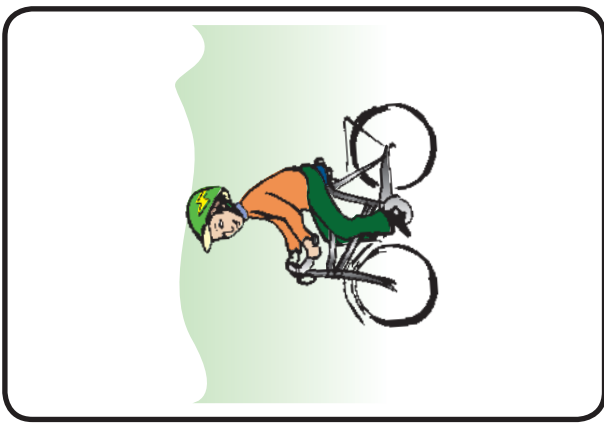

cycling



**playing
in the
snow**

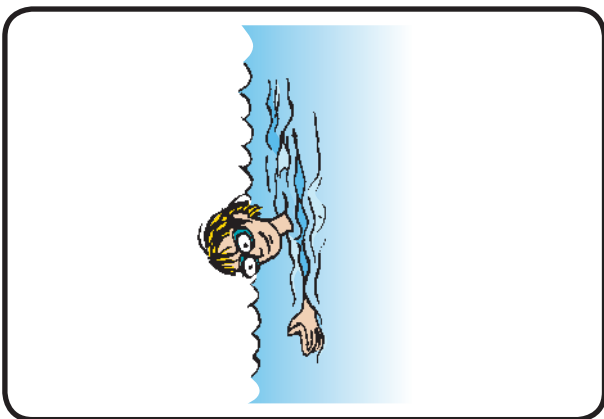

swimming

What can you do • Memory, ect. 1 (2) 3 4



making
a snowman

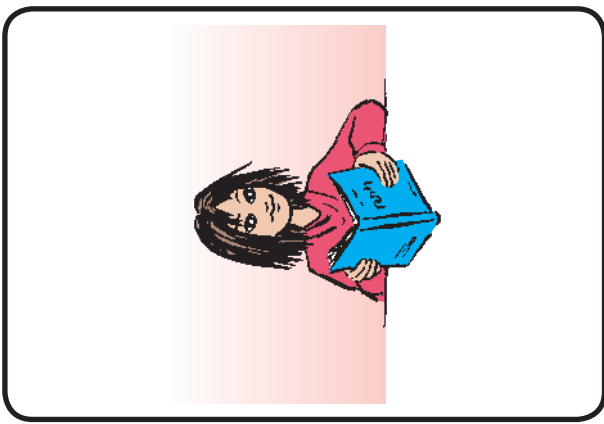

reading
a book

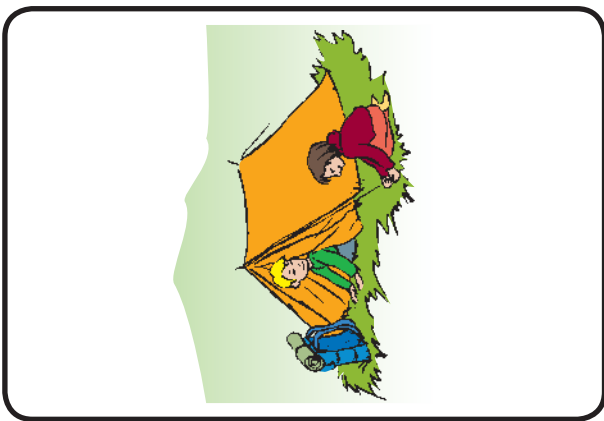

camping

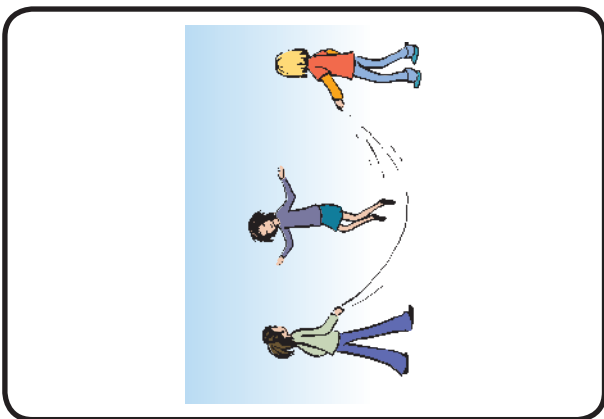

playing
outdoor
games

What can you do • Memory, ect. 1 2 **3** 4



playing
the
computer

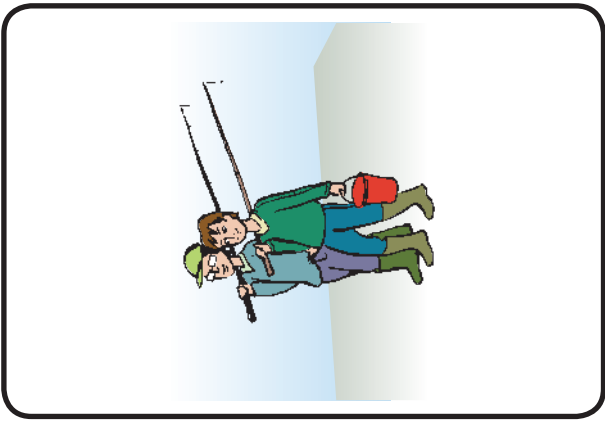

going
fishing

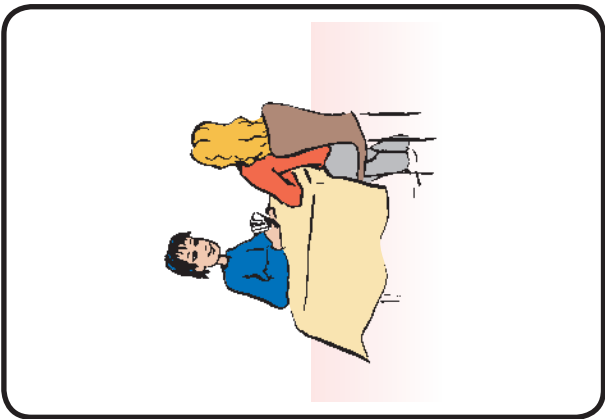

playing
indoor
games

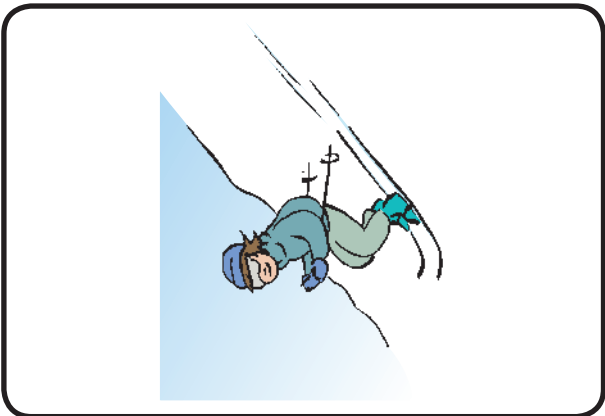

skiing

What can you do • Memory, ect. 1 2 3 4



riding

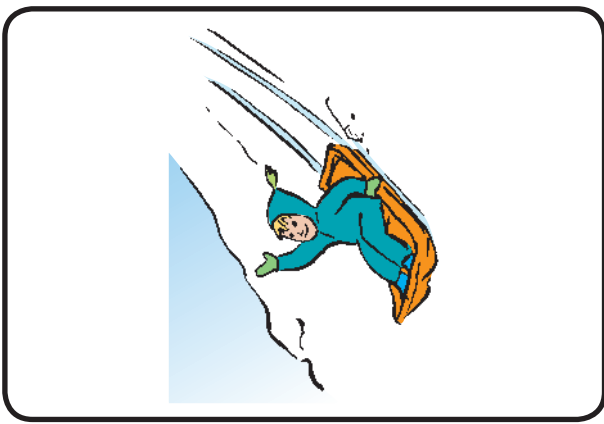

sledging



hiking
walking
in
the mountans



skating

What can you do • domino (1) 2

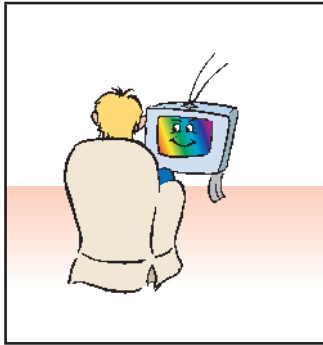

He is riding
on his bike



They are playing
in the snow



He is swimming

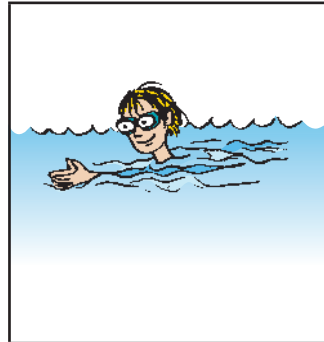

They are making
a snowman



She is reading
a book

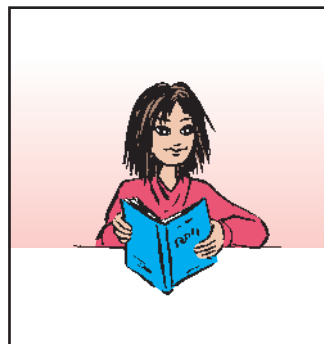

They are
camping



They are playing
outdoor games -
skipping rope

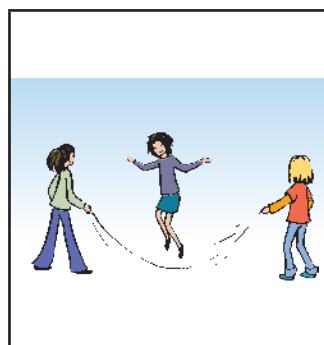

He is playing
computer games

Domino kann m.a. nýtast sum lesivenjing.

Tveir næmingar arbeiða saman,
ella ein næmingur leggur alt spælið.

Spælipláturnar kunnu evt. gerast størri.

What can you do • domino 1 (2)



They are
going fishing

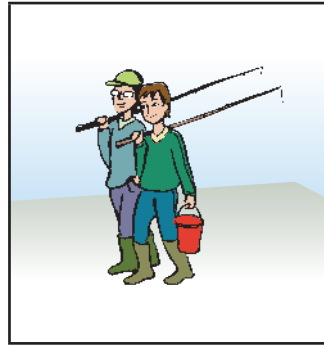

They are playing
indoor games -
playing cards

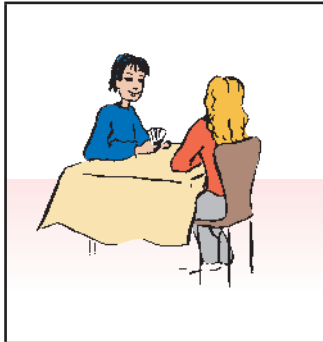

She is skiing



She is riding

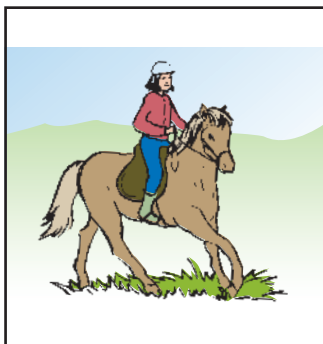

He is sledging



They are walking
in the mountains -
hiking

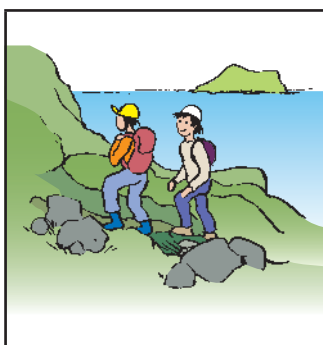

She is skating



He is watching
television

Hobbies and sports • Memory, ect.

① 2 3 4 5

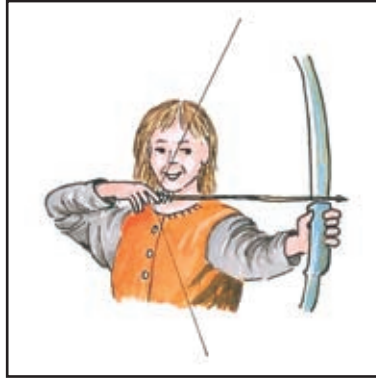

acting

archery

athletics

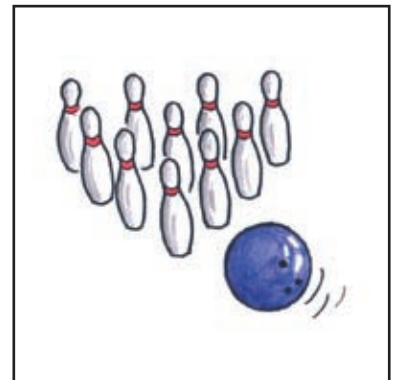

badminton

basketball

bowling

Hobbies and sports • Memory, ect. 1 (2) 3 4 5



chess

**collecting
things**

**computer
games**

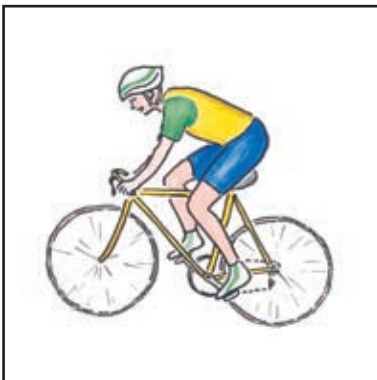

cycling

dancing

drawing

Hobbies and sports • Memory, ect. 1 2 (3) 4 5



fishing

football

gymnastics



handball

**horseback
riding**

jogging

Hobbies and sports • Memory, ect. 1 2 3 **4** 5



judo

**listening
to music**

needlework



painting

**playing
the piano**

reading

Hobbies and sports • Memory, ect.

1

2

3

4

5



rollerblading

singing

swimming

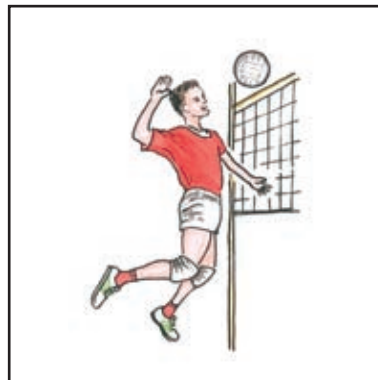
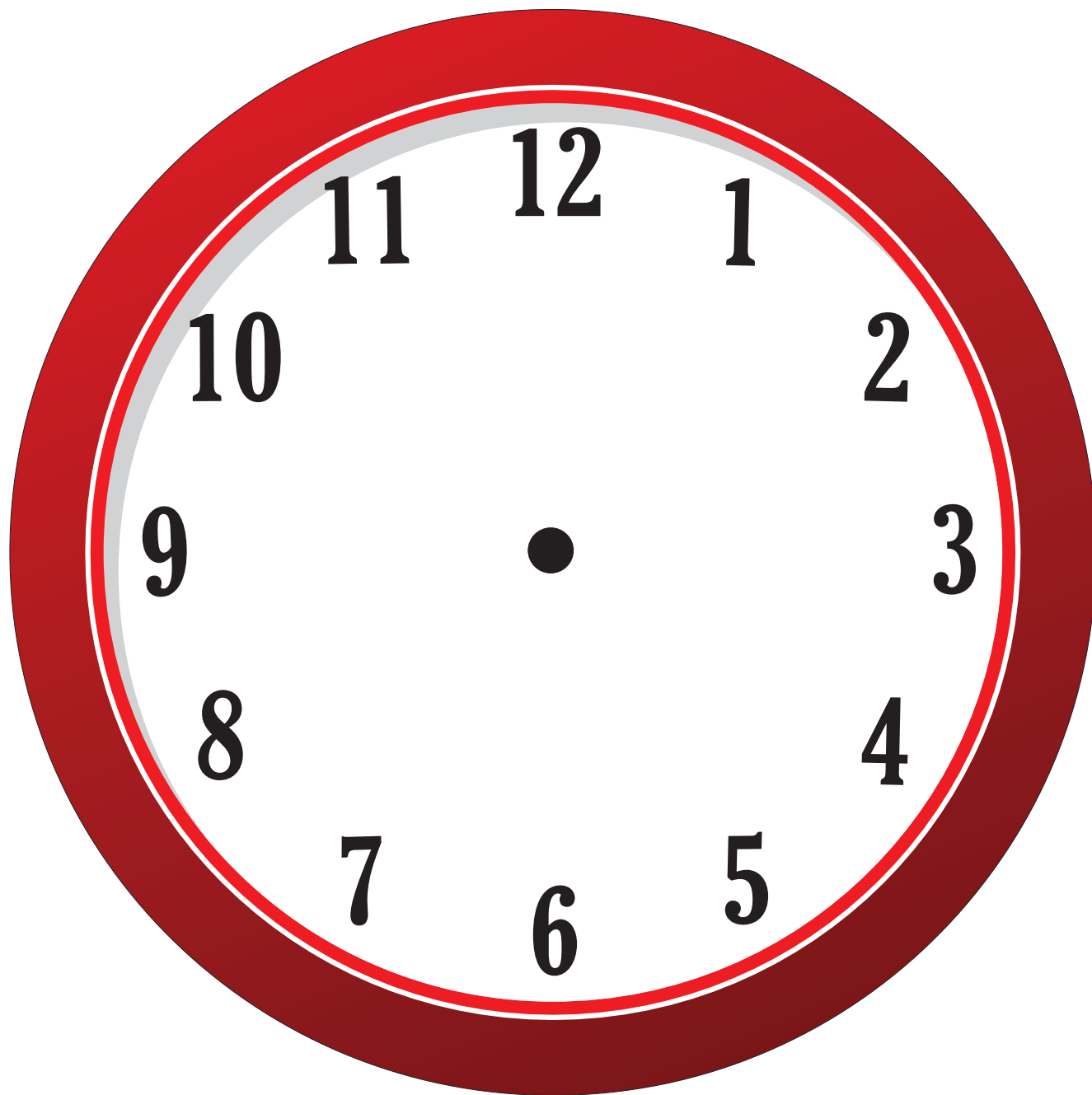

table tennis

volleyball

**watching
television**

The clock



Klipp út og laminera.
Set saman við brævklemmu.

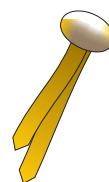

The clock • word cards, ect. (1) 2 3 4 5

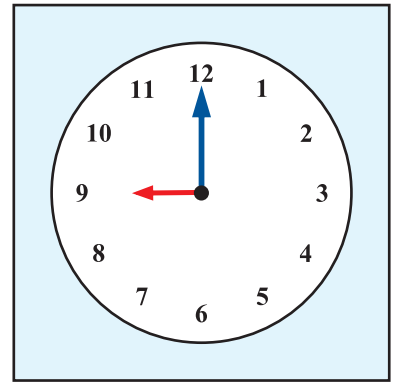
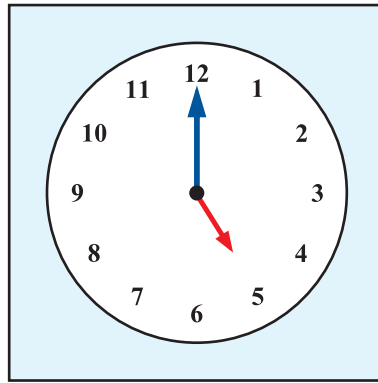
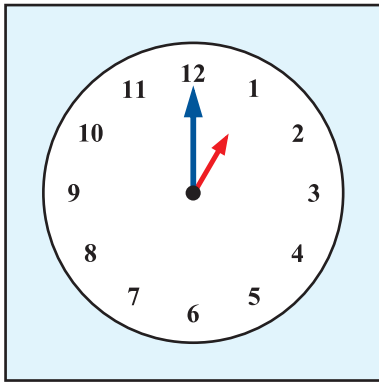

It's **one**
o'clock

It's **five**
o'clock

It's **nine**
o'clock

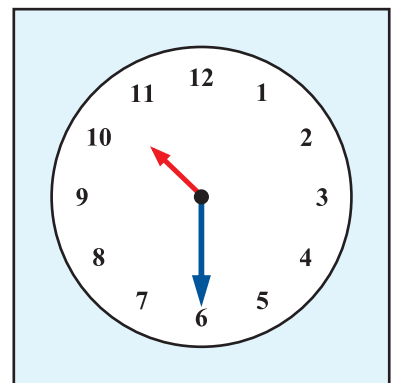
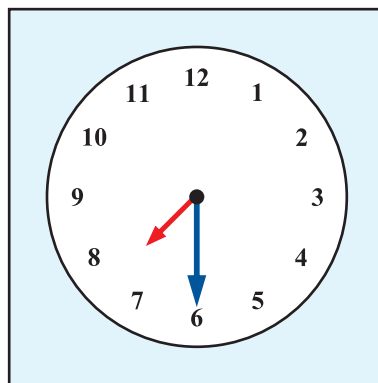
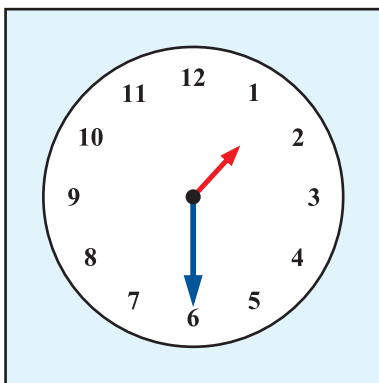

It's **half**
past one

It's **half**
past seven

It's **half**
past ten

The clock • word cards, ect. 1 (2) 3 4 5

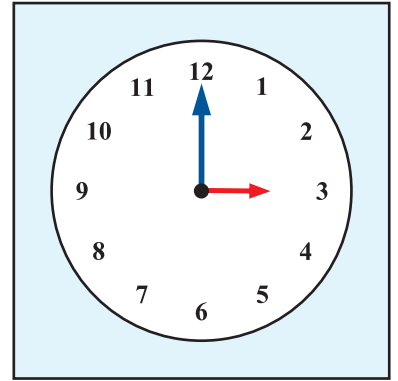
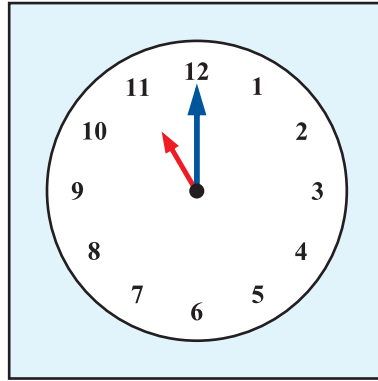
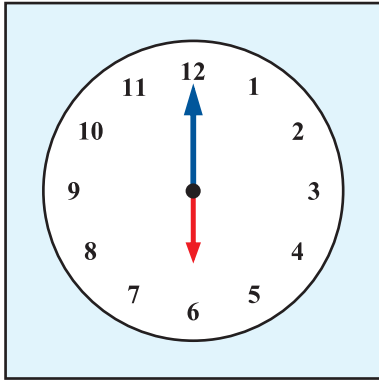

It's **six**
o'clock

It's **eleven**
o'clock

It's **three**
o'clock

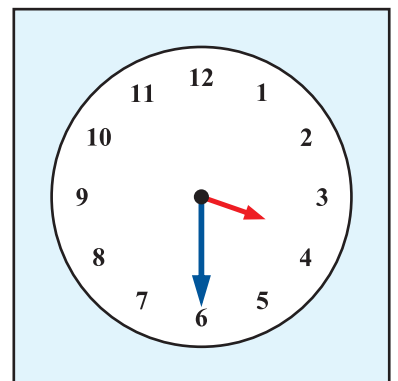
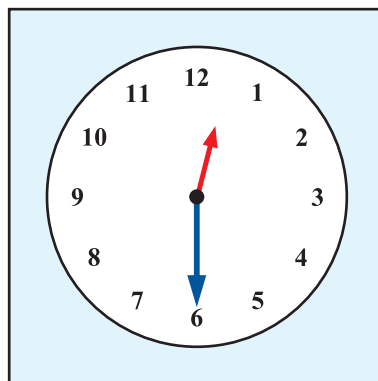
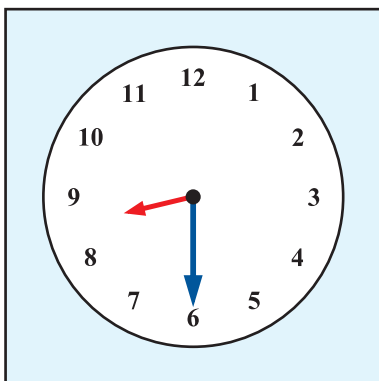

It's **half**
past eight

It's **half**
past twelve

It's **half**
past three

The clock • word cards, ect. 1 2 (3) 4 5

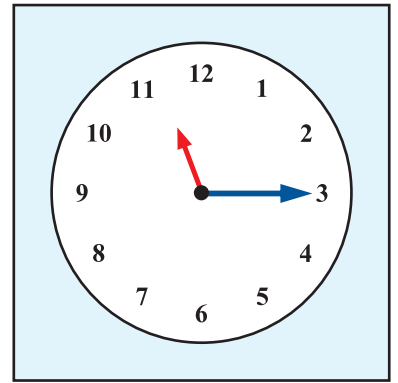
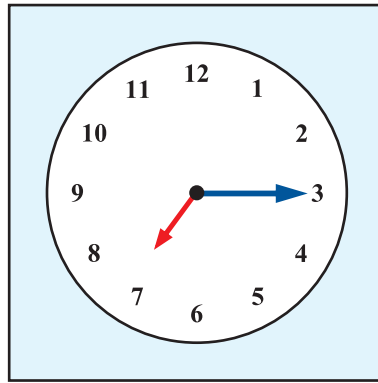
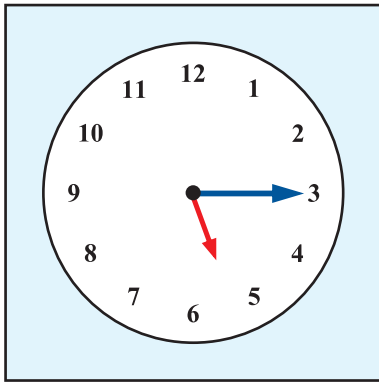

It's a quarter
past five

It's a quarter
past seven

It's a quarter
past eleven

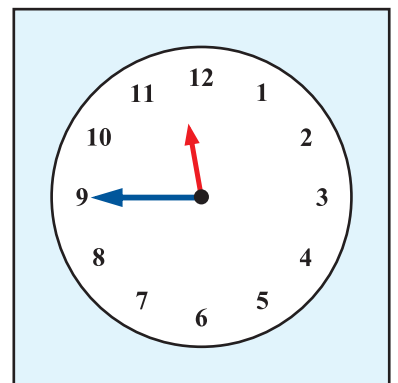
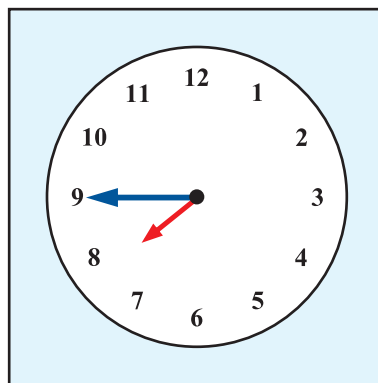
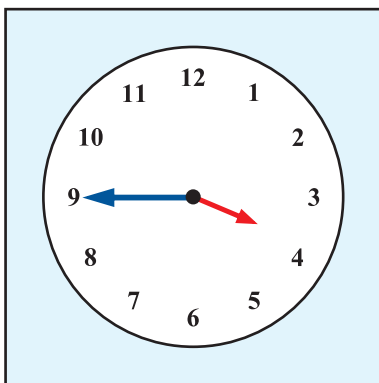

It's a quarter
to four

It's a quarter
to eight

It's a quarter
to twelve

The clock • word cards, ect. 1 2 3 4 5

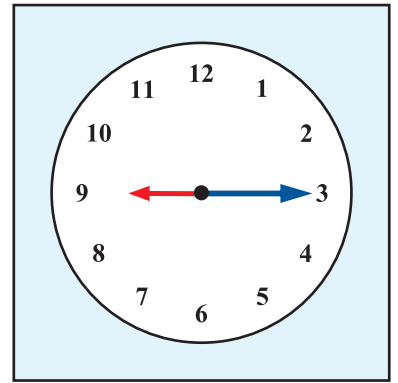
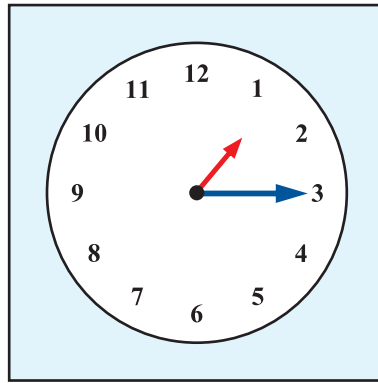
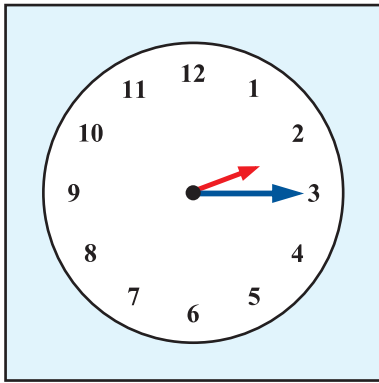

**It's a quarter
*past two***

**It's a quarter
*past one***

**It's a quarter
*past nine***

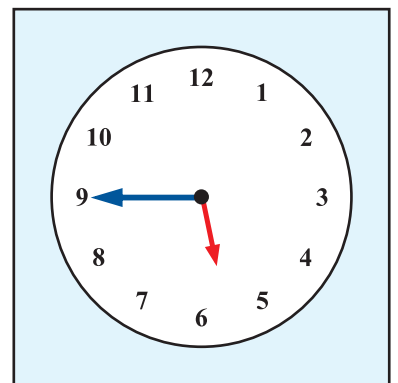
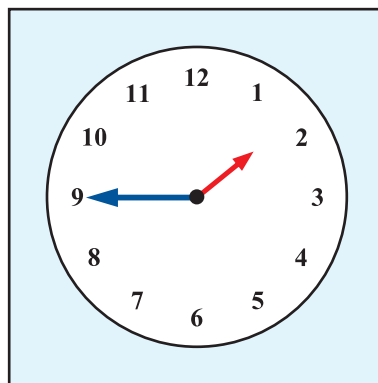
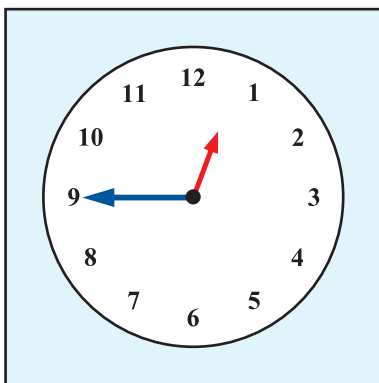

**It's a quarter
*to one***

**It's a quarter
*to two***

**It's a quarter
*to six***

The clock • word cards, ect. 1 2 3 4 (5)

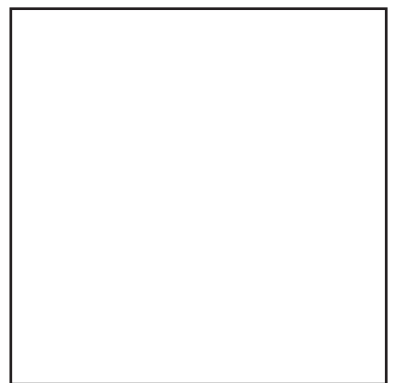
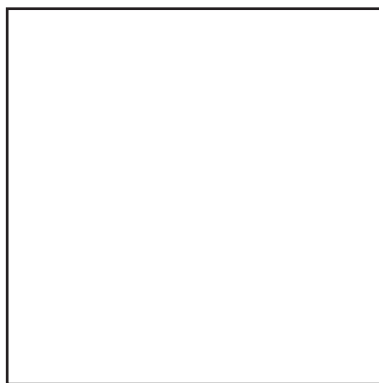
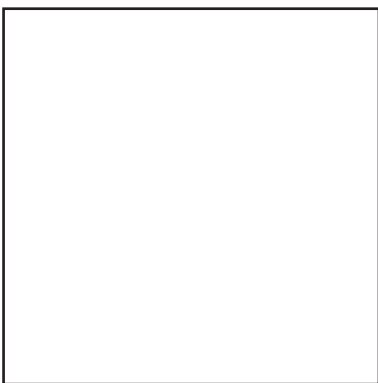
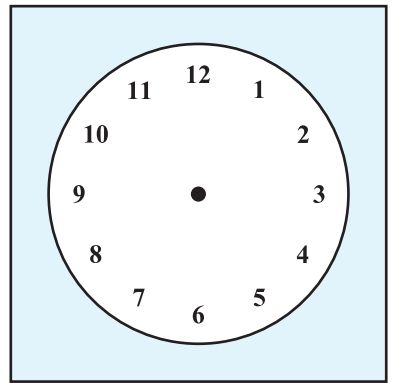
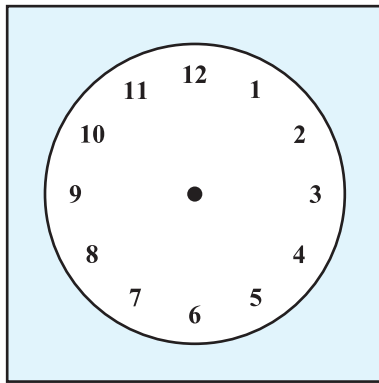
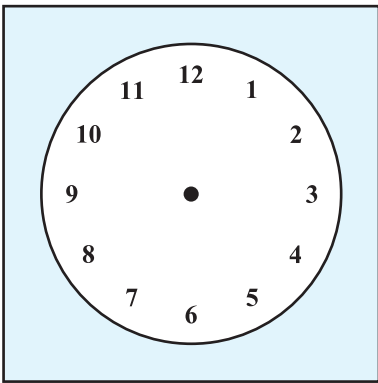
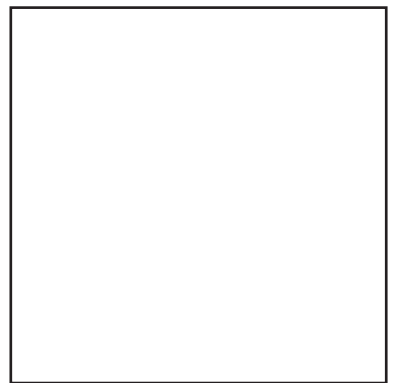
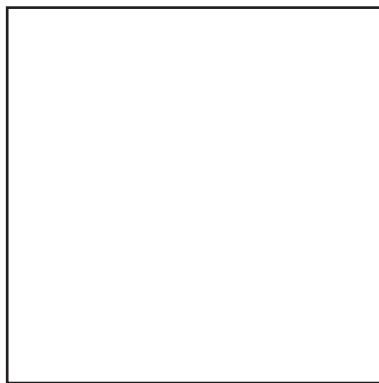
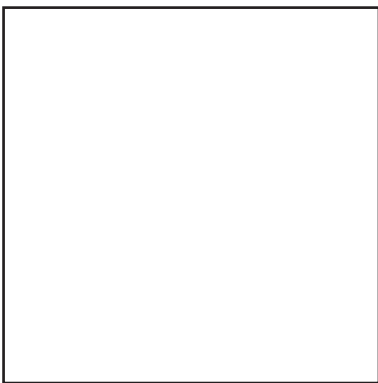
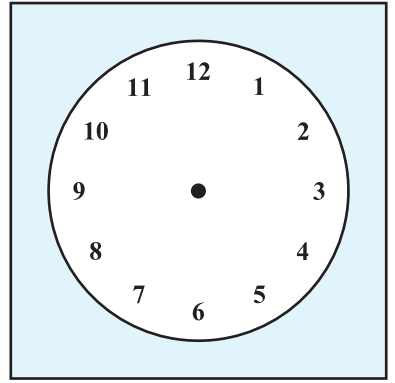
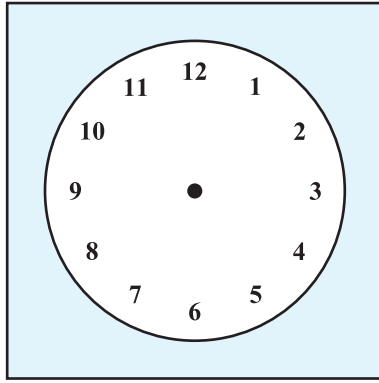
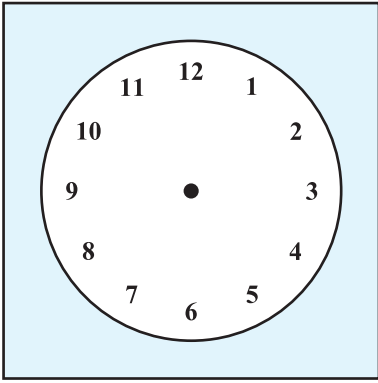

Peter and Mandy go fishing • Domino ① 2 3

**Peter and Mandy
go fishing**



Peter's father
has a small fishing boat.
He is home now,
and he has promised
to take the children out fishing.



The weather is good,
and the sea is calm,
but the children have to wear
life jackets.



They sail along the cliffs,
and see many different birds.
The kittiwakes
make a lot of noise.



Mandy thinks
that the puffins are beautiful.



Suddenly Mandy sees a seal
popping its head
out of the water.
It looks straight at them,
but when they get closer,
it disappears.



Peter and Mandy go fishing • Domino 1 2 (3)

They only go for a short trip.
Peter's father has brought along
two fishing rods,
and he teaches Mandy
how to fish.



They catch twelve fish;
four are cod,
and the rest are coalfish.



When they get home,
Peter's mother makes fish balls.

Mandy tells her
that she really enjoyed fishing.



What's on the table?

Breakfast



				3		4				5		6
		2										
1												
					7							
	8											
9												

- Words**
- bread
 - butter
 - cereal
 - chocolate cream
 - coffee
 - jam
 - milk
 - tea
 - yoghourt

Meals • Svarlisti 1 2 3 4

Breakfast

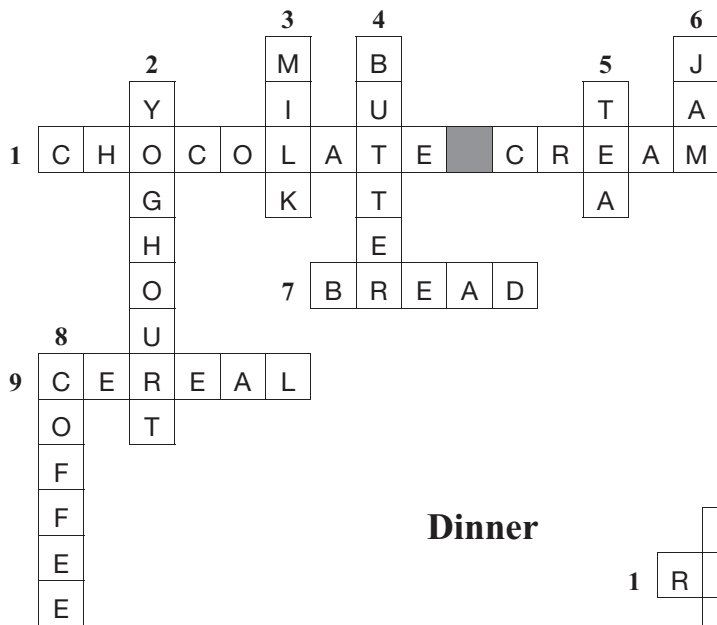

Dinner

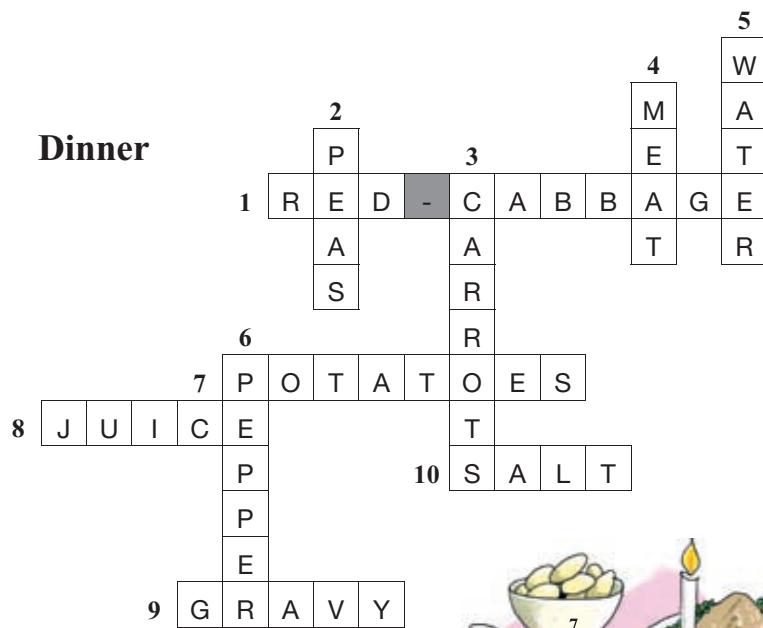

Supper

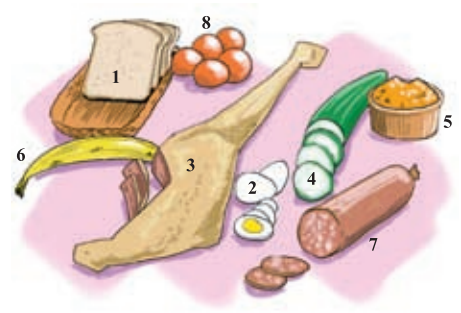
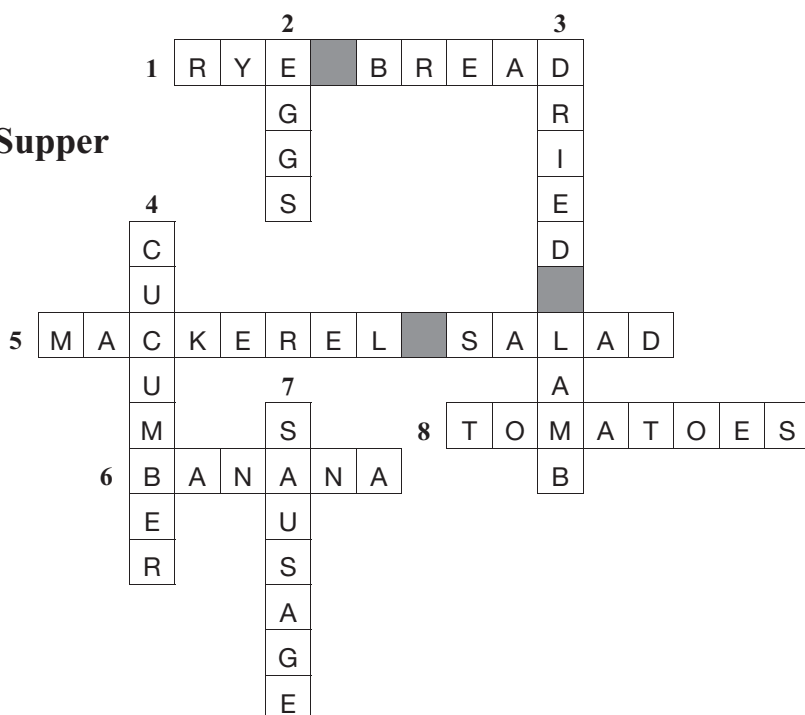

What do you wear?

Find suitable clothes.



On a cold
winter day

I wear:



On a windy
autumn day

I wear:

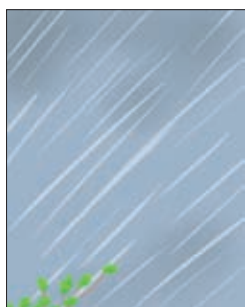

On a wet
spring day

I wear:



On a warm
summer day

I wear:

blouse	trousers	jacket	socks (woollen)	shoes
shirt	jeans	coat	hat (woollen)	sandals
T-shirt	shorts	raincoat	cap	trainers
sweatshirt	skirt	scarf	gloves	boots
sweater	dress		mittens	wellingtons
cardigan	track suit			

suitable: *hóskandi*

woollen hat: *ullint húgva*

Helping on the farm • Domino ① 2 3

Helping on the farm



Peter sometimes helps
his grandfather on the farm.

During the winter,
they feed the sheep.



The farmer
has built sheep houses
so that the sheep can stay indoors
when the weather is bad.



In spring,
the new lambs are born.
Every day in the lambing season
the go out
into the fields to see
how the lambs are doing.



In summer,
the sheep shed their wool,
and therefore they must be
sheared.



In autumn,
some of the sheep
are slaughtered.



Helping on the farm • Domino 1 2 3

Peter helps to drive the sheep
from the outfield
into the fold.



Peter likes to watch
when they slaughter the sheep.



The other sheep
are let out again.

They soon find their way back
into the outfield



Sheep words • (Tekstbook, page 60-62, picture dictionary, page 99)

Crossword

Words

- lamb
- outfield
- shears
- sheep
- sheepfold
- sheep house
- sheep skin
- shepherd
- storehouse

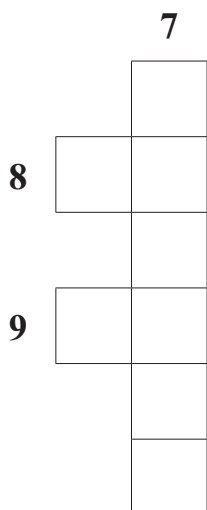

1

2

3

4

5

6

7

8

9

A crossword puzzle grid with 9 numbered starting points. The grid consists of white squares for letters and grey squares for empty space. The numbers are: 1 (vertical, 10 squares), 2 (vertical, 5 squares), 3 (vertical, 3 squares), 4 (horizontal, 7 squares), 5 (horizontal, 6 squares), 6 (horizontal, 9 squares), 7 (vertical, 3 squares), 8 (horizontal, 8 squares), and 9 (horizontal, 4 squares).

Christmas • memory, word cards, etc.

① 2 3

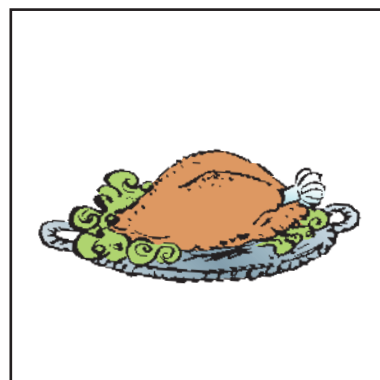
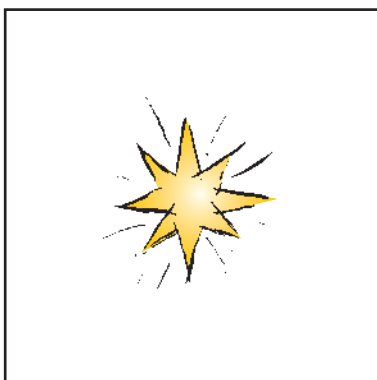
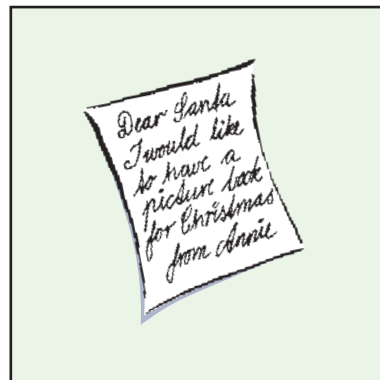
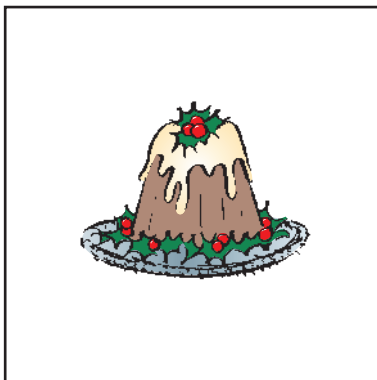

Christmas presents

Christmas pudding

a letter

Christmas cards

star

turkey

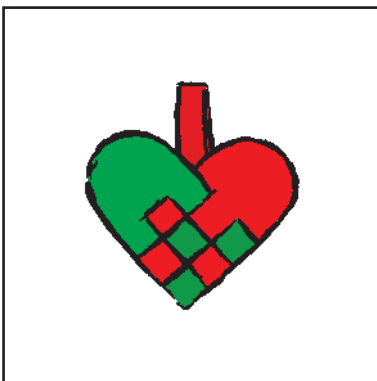
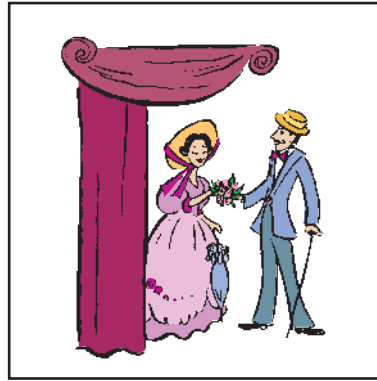

**Christmas
tree**

theatre

fireplace

heart

**Father
Christmas**

stocking

Christmas • memory, word cards, etc.

1

2

3

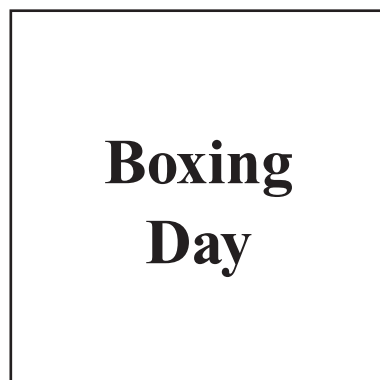
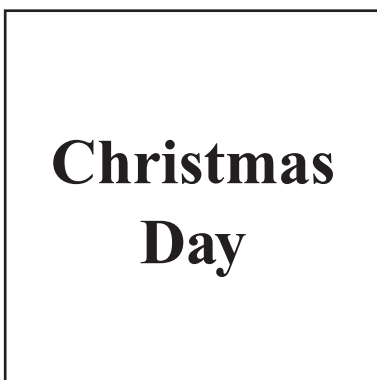
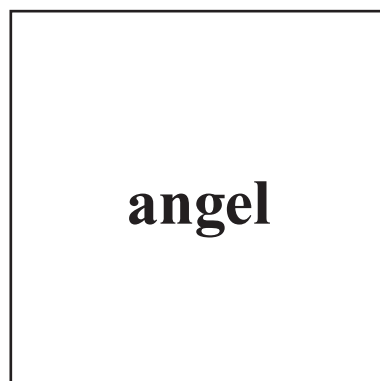
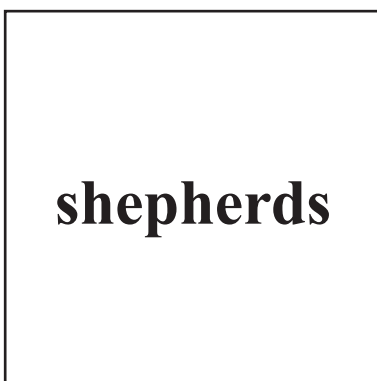
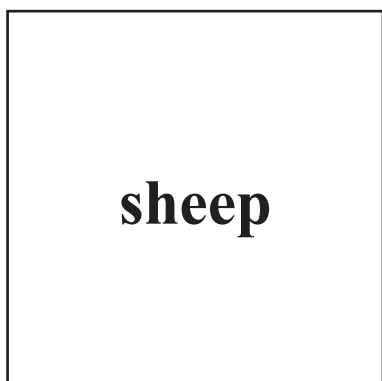
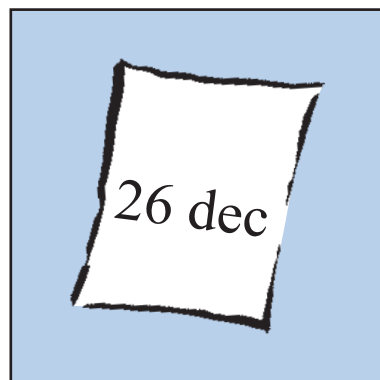
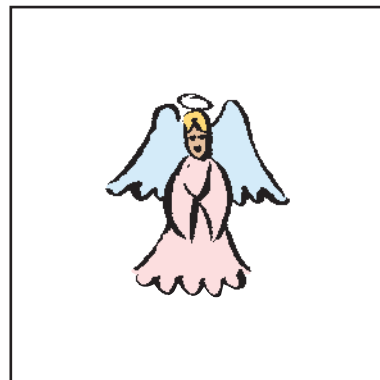
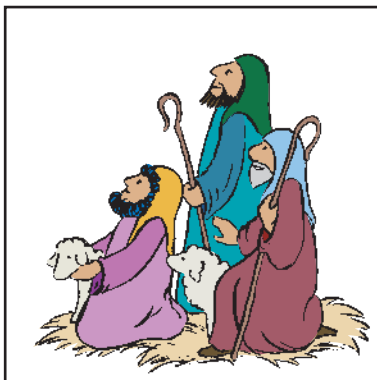
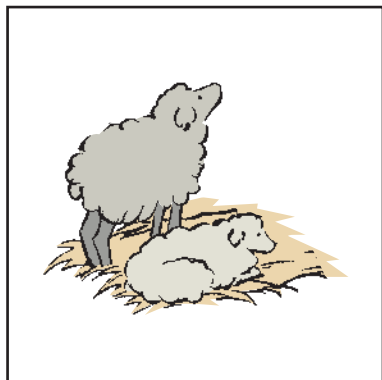





Christmas • Domino (1) 2

	Father Christmas		stocking
---	-----------------------------	--	-----------------









	Christmas tree		theatre
---	---------------------------	--	----------------

	fireplace		Christmas presents
---	------------------	--	-------------------------------

	Christmas pudding		a letter
---	------------------------------	--	-----------------

	Christmas cards		star
---	----------------------------	--	-------------

Christmas • Domino 1 (2)

	sheep		Christmas Eve
	shepherds		Christmas Day
	angel		Boxing Day
	turkey		heart

Domino er gott, tá ið orð og máliskur skulu lærast.
Tað kann leggjast av teimum næmingum, ella ein næmingur leggur tað einsamallur.

Put a tail on the donkey • spæl

Ger myndina størri (A3).

Líma hana á stívt pappír og set hana upp á uppslagstalvuna í passaligari hædd.

Laminera halan ella líma hann á stívt pappír.

Spælireglur eru á síðu 73 í lærarabókini.

Klipp her.

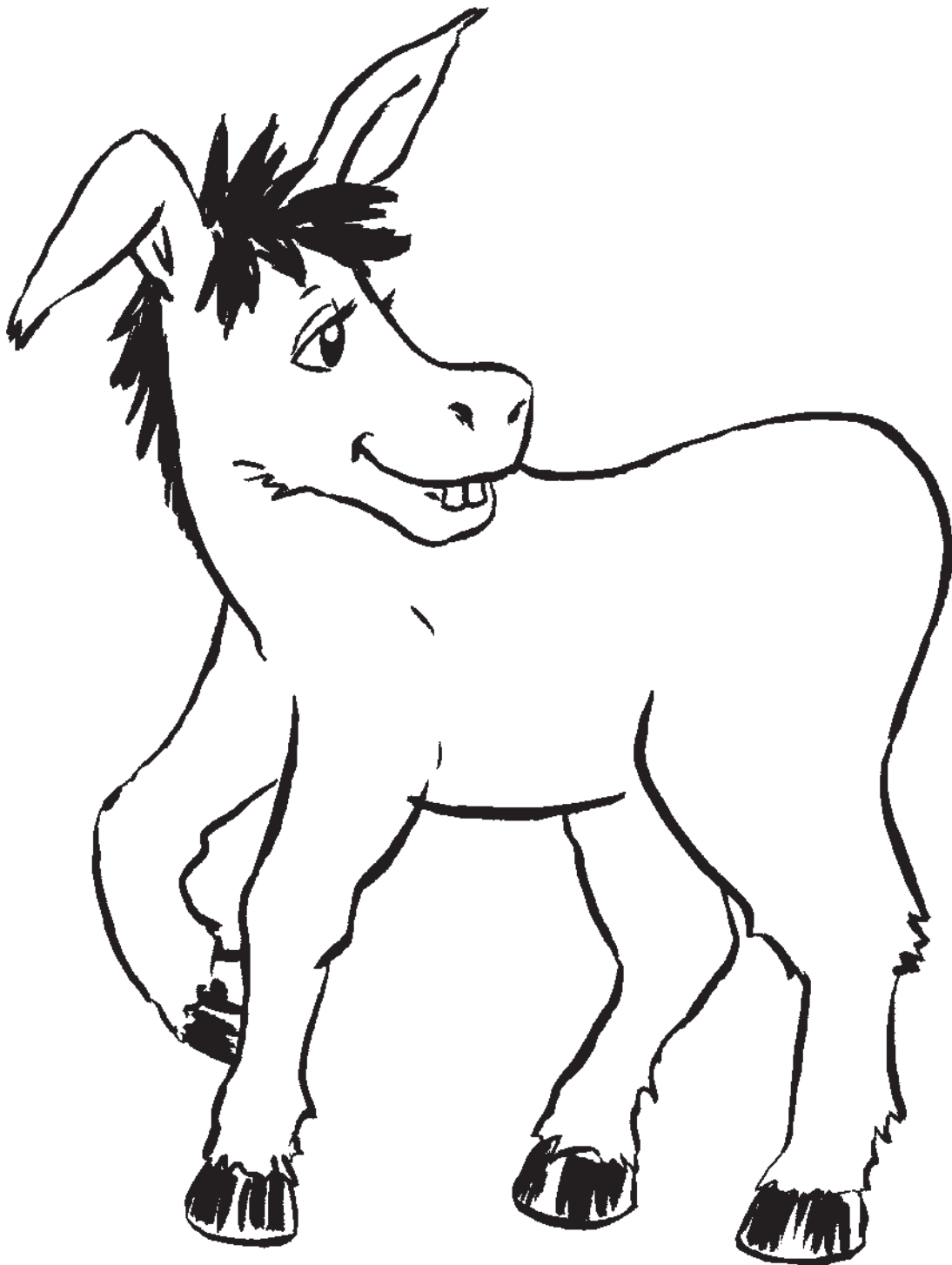

Rammur til spøl • 9 rammur

Rammur til spøl • 8 rammur



Rammur til spøl • 12 rammur

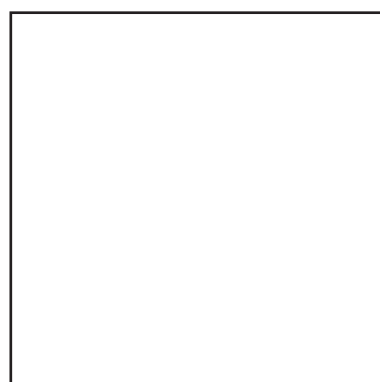
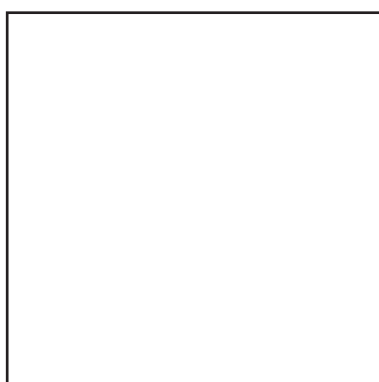
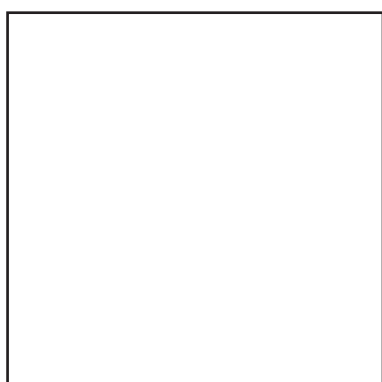
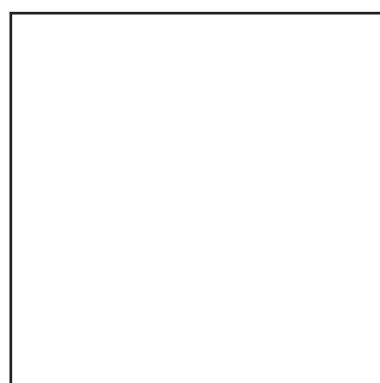
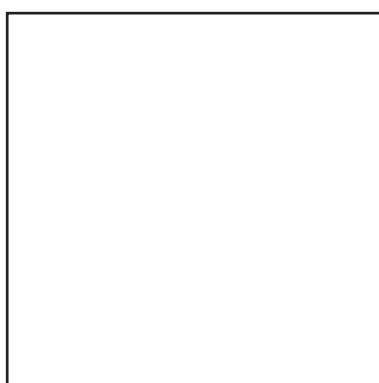
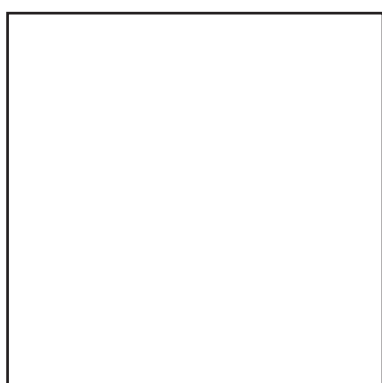
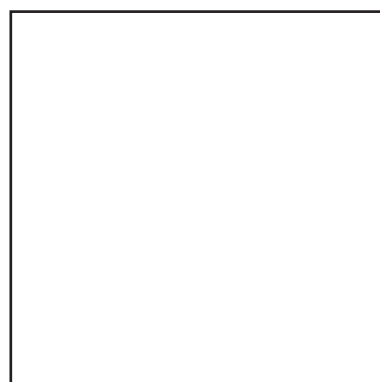
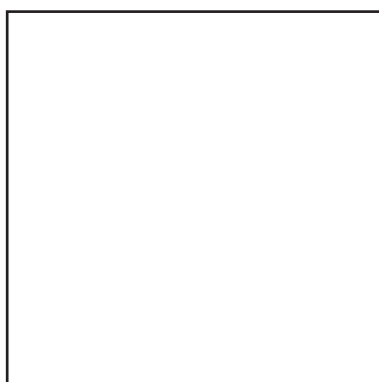
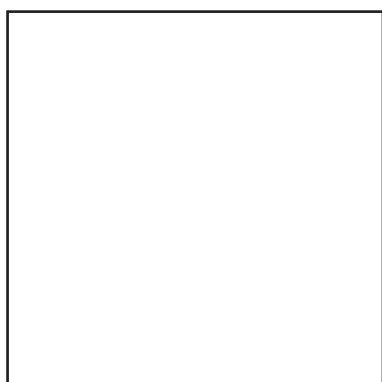
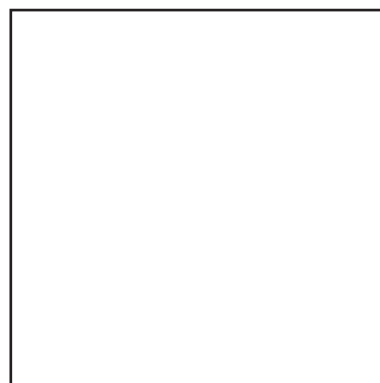
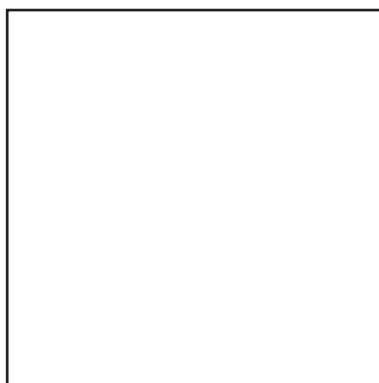
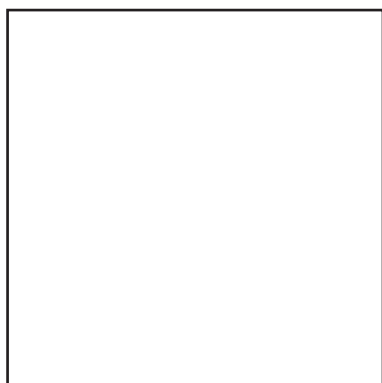

Rammur til spøl • Picture lottery

Rammur til spøl • Domino

--	--

--	--

--	--

--	--

--	--

--	--

--	--

--	--

--	--

--	--

Bingoplátur • 4 puntar

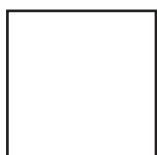
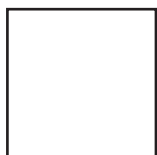
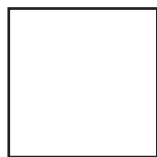
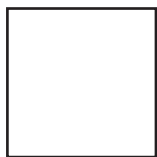
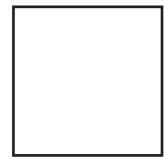
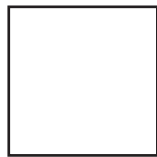
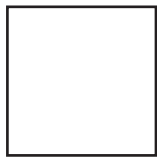
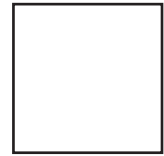
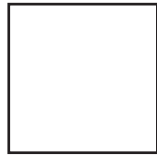
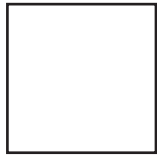
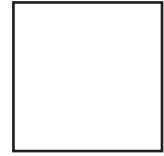
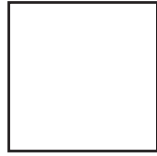
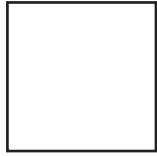
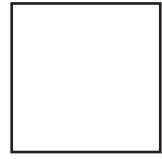
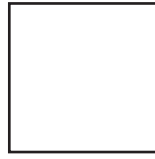
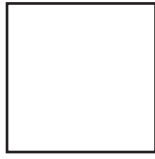
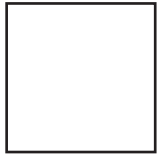

Bingoplátur • 9 puntar



